

目 录

一、运输作业组织与管理模块	2
1. 1-1	2
2. 1-2	5
3. 1-3	7
4. 1-4	10
5. 1-5	13
6. 1-6	16
7. 1-7	19
8. 1-8	22
9. 1-9	24
10. 1-10	30
二、仓储与配送作业组织与管理模块	34
1. 2-1	34
2. 2-2	40
3. 2-3	46
4. 2-4	52
5. 2-5	58
6. 2-6	63
7. 2-7	70
8. 2-8	76
9. 2-9	82
10. 2-10	88
11. 2-11	94
12. 2-12	98
13. 2-13	103
14. 2-14	108
15. 2-15	113
16. 2-16	118
17. 2-17	125
18. 2-18	131
19. 2-19	137
20. 2-20	143
三、国际物流作业组织与管理模块	150
1. 3-1	150
2. 3-2	152
3. 3-3	155
4. 3-4	158
5. 3-5	161
6. 3-6	164
7. 3-7	166
8. 3-8	168
9. 3-9	172

10.	3-10	175
11.	3-11	177
12.	3-12	179
13.	3-13	181
14.	3-14	184
15.	3-15	188
16.	3-16	190
17.	3-17	193
18.	3-18	195
19.	3-19	197
20.	3-20	199
21.	3-21	202
22.	3-22	204
23.	3-23	207
24.	3-24	208
25.	3-25	210
四、 快递物流作业组织与管理模块.....			213
1.	4-1	213
2.	4-2	216
3.	4-3	219
4.	4-4	224
5.	4-5	228
6.	4-6	231
7.	4-7	234
8.	4-8	238
9.	4-9	242
10.	4-10	246
11.	4-11	249
12.	4-12	252
13.	4-13	255
14.	4-14	258
15.	4-15	261
16.	4-16	264
17.	4-17	267
18.	4-18	271
19.	4-19	274
20.	4-20	277
21.	4-21	280
22.	4-22	283
23.	4-23	287
24.	4-24	290
25.	4-25	293

湖南商务职业技术学院物流管理专业学生技能考核题库

4

13

1				7
				1
				1
				1
2			ABC	10
				5
				5
3				8
				8
				9
4				10
				5
				10

一、运输作业组织与管理模块

1. 1-1

(1)

4538		MB1. 2/		88
	MB145		100	360
				100

①

20

②

10

③

20

--	--	--

④

10000

4

6000

15

⑤

15

2

	2	30
		1 30 40
0	5	
	30	
30	2	

3

60

4

2

100

20%

80%

1

1

--	--	--	--	--

(20)	5		2	0
	5		3	
	10		2	
(80)	20		3	0
	15		5	
	10		2	
	15		5	
	20		1	

2. 1-2

(1) 任务描述

1.2 / .	25	5123
330	100	165 (
100	100	
333)		
1 >=300		
<2 98%		
2<= <4 96%		
4<= <6 94%		
>=6 92%		
2 <300		
<2 100%		
2<= <4 98%		
4<= <6 96%		
>=6 94%		
:		
①		
20		
②	10	
③		5000
4		
		300000

④

20

/								
/								
			kg	m ³				
□ □			□ □					
□ □								
						□ □ □ □		
	3							

⑤

15

2

	2	30	
	1 30 40		
0	5		
	30		
30	2		

3

60

4

2

100

20%

80%

1

1

(20)	5		2	0
			3	
	5		2	
			3	
	10		5	
			5	
(80)	20		15	5
			15	
	20		1	
				15
	15			
	10		10	

3.

1-3

(1) 任务描述: 2010 8 12

500 500 160 15

8 15 2010 8 16 0.4 / 1‰ 2010

①

10

②

20

③

15

*		*	*		*	*	
*			*			*	

④

15

⑤

20

2

	2	30
	1	30 40
0	5	
	30	
30	2	

3

60

4

2

100

20%

80%

1

1

(20)	5		2	
			3	
	5			2
			3	
	10			5
			5	

					0
(80)		15		10 5	
		20		15	5
		15			1
		20			10
		10		10	10

				17.04
				5
				4 8
				1920 /
				923
				48 /
				2000
				320
				2000
				500
				800
				200
				1000
				8

②

15



17.5

17.5

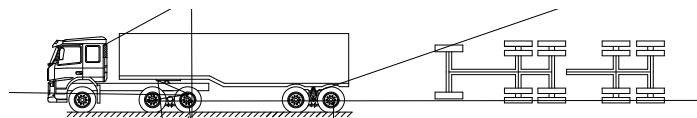

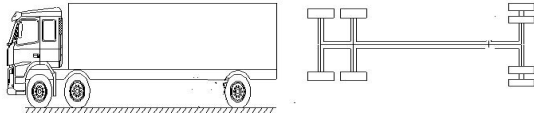

9.6

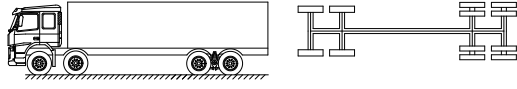

9.6

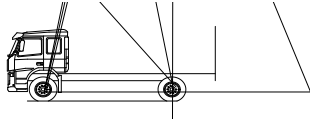

(20)	5		2	
	5		3	2
	10		3	5
				0
	15		5	10
	20		1.5	2 2.5
	15		3	
	15		15	
	15		15	

5. 1-5

(1) 任务描述:

1

		35
		20
		20

K 1011150008

64

		35
		20
		10

DD1011150012

102

		30
		35
		30

2

3



①

01

02

03

A

B

C

20
 ② A B A
 20 0.03³ B 10
 0.02³ 10 20³
 90% A B
 100% 20
 ③ 10
 ④ 10
 ⑤ 10

2

	2	30
	1	30 40
0	5	
	30	
30	2	

3

60

4

2 100
 20% 80%
 1
 1

(20)	5		2
		3	

		5			2
				3	
		10			5
				5	
					0
(80)		20		10	10
		20		15	5
		15		15	2
		15		5	10
		10			5

6. 1-6

(1) 任务描述

D

2015 9

5,600

9,600

121

5

400 / , 130 70 30

5000

666

① 15

② D 1.65 /

347 / 4‰ 10

25 / 12 250 /

20

③ 20

D

/									
/									
*	*	*	* kg	* m ³	*	*	*	*	
<input type="checkbox"/> <input type="checkbox"/>			<input type="checkbox"/> <input type="checkbox"/>						
<input type="checkbox"/> <input type="checkbox"/>									
*						<input type="checkbox"/> <input type="checkbox"/> <input type="checkbox"/> <input type="checkbox"/>			
	3								

④ D

15

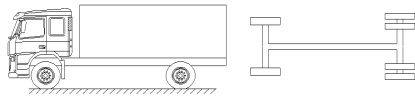
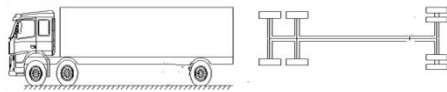
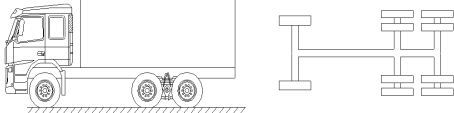
	1	4X2	
			
			

⑤

10

2

	2	30	
	1	30	40
	5		0
	30		
	30	2	

3

60

4

2

100

20%

80%

1

(20)	5		2
		3	

		5			2
				3	
		10			5
				5	
					0
(80)		15		10	
				5	
		20		15	5
		20		2	
		15		2	
	15		15		
		10		5	5

7. 1-7

(1) 任务描述

" " "

" " "

" " "

"

1/3

①

②

15

10

③

15

1 4X2

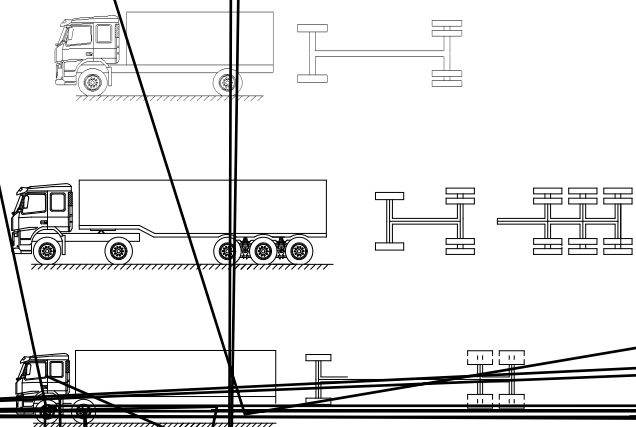

⑤

10000

4

3000

15000

20

2

	2	30
	1	30 40
0	5	
	30	
30	2	

3

60

4

2

100

20%

80%

1

1

(20)	5		2
			3
	5		2
			3
	10		

			5	0
			5	
(80)		15	10 5	
		15	2 15	
		20	10 10	
		20	15 5	
		10	1.5 10	

8. 1-8

(1) 任务描述

26 60
556 6 6
1 14.6 / 2 0.0704 /

①

20

②

15

③

10

④

,

15

⑤

20

2

	2	30
	1	30 40

	0	5	
		30	
	30	2	

3

60

4

2

100

20%

80%

1

1

(20)	5		2	0
			3	
	5		2	
			3	
	10		5	
(80)	20		15	
			5	
	15		10	
			5	

		10		10	
		15		5 10	
		20		10 5 5	

9. 1-9

(1) 任务描述

() ()

Marks & Nos.	Descriptions	NO.of Packages ()	Measurement ()	Gross Weight KGS	Net Weight KGS	Total Price USD
AL DAH	CLEANING BALL	3500	53CMX21CMX15CM 0.0167M3/	12kg/	11kg/	1000

()
()
()
()
()

THC TERMINAL HANDLING CHARGE	USD100/20GP USD150/40GP USD150/40HQ	
ORC ORIGIN RECEIPT CHARGE	USD190/20GP USD310/40GP USD310/40HQ	THC
BAF Bunker Adjustment Factor	USD394/20GP USD 788/40GP USD 788/40HQ	
AMS America manifest system	USD25/	
DHF Document handling fee	USD50/	
SLF SEAL FEE,	USD50/20GP USD 30/40GP USD 30/40HQ	
PSS:Peak Season Sucharges	USD30/20GP USD 30/40GP USD 30/40HQ	

①

()				

②

COSCO CONTAINER LINES

Sailing Schedule from : Shenzhen,Shenzhen,Guangdong,China	
To : Los Angeles,Los Angeles,CA,United States	
Origin City : Shenzhen,Shenzhen,Guangdong,China	CY/DOOR
Destination City : Los Angeles,Los Angeles,CA,United States	CY/DOOR

序列号	航线	船名	航次	截关时间	装货港	预计离港时间	实际离港时间	卸货港
1	YPSW	YM UNISON	59E	2016-04-22 17:00	Yantian	2016-04-25		Los Angeles
2	SEA	NORTHERN JAVELIN	002E	2016-04-23 12:00	Yantian	2016-04-27		Long Beach
3	AAS2	CMA CGM LIBRA	095TXE	2016-04-25 16:00	Yantian	2016-04-28		Long Beach
4	YPSW	YM UBIQUITY	22E	2016-04-29 17:00	Yantian	2016-05-02		Los Angeles
5	SEA	C SCL PUSAN	117E	2016-04-30 12:00	Yantian	2016-05-04		Long Beach
6	AAS2	CMA CGM COLUMBA	097TXE	2016-05-02 16:00	Yantian	2016-05-05		Long Beach
7	SEA	COSCO NINGBO	069W	2016-05-06 11:00	Yantian	2016-05-08		Long Beach
8	YPSW	YM JIREBY	50E	2016-05-06 17:00	Yantian	2016-05-09		Los Angeles
9	SEA	COSCO EXCELLENCE	027E	2016-05-07 12:00	Yantian	2016-05-11		Long Beach
10	AAS2	CMA CGM CENTAURUS	099TXE	2016-05-09 16:00	Yantian	2016-05-12		Long Beach
11	YPSW	YM MASCULINITY	32E	2016-05-13 17:00	Yantian	2016-05-16		Los Angeles
12	SEA	HONG KONG BRIDGE	039E	2016-05-14 12:00	Yantian	2016-05-18		Long Beach
13	AAS2	CMA CGM THALASSA	101TXE	2016-05-16 16:00	Yantian	2016-05-19		Long Beach

③

COSCO CONTAINER LINES

干货箱								
	箱体内部尺寸			箱体内容积及载重量		箱门开度尺寸		
	L	W	H	Cu	P	W	H	
	20'	5898	2352	2393	33.2	21740/28230#	2340	2280
	40'	12032	2352	2393	67.7	26630	2340	2280
HC	12032	2352	2698	76.3	26520	2340	2585	

冷藏箱						
	箱体内部尺寸			箱体内容积及载重量		
	L	W	H	Cu	P	
	20'	5444	2284	2267	28.5	21135/27160#
	40'	11583	2284	2250	58.7	26580
HC	11583	2284	2550	67.9	26380	

开顶箱						
	箱体内部尺寸			箱体内容积及载重量		
	L	W	H	Cu	P	
	20'	5900	2330	2337	32.6	21740
	40'	12025	2330	2337	65.8	26410

④

⑤

(2) 实施条件

	2	30
		1 30 40 0
	5	
	30	
	30	2

(3) 考核时量

60

(4) 评分细则

		1	2	100
		20%	80%	
		1		
(20)	5		2	3
	5		2	3
	10		5	0
(80)	20		1	
			5	5
	15		3	2
	20		3	2

		15			

10. 1-10

(1) 任务描述

LX DO
(computer parts)

2014 10 7 20 00
60X50X40CM 10kg/ 16000 /
5

		EK		LA		
M	-45	+5	+100	+300	+500	+1000
500	32	2	19	18	17	16

①

*Shipper("The Customer")		Mawb No:	Hawb No.:
*Consignee			
Notify Party Tel: Fax:			
Name of Carrier	*Departure Airport	*Airfreight Charges: <input type="checkbox"/> Prepaid <input type="checkbox"/> Collect	Other Charges: <input type="checkbox"/> Prepaid <input type="checkbox"/> Collect
*Destination	Country of Origin(Goods):		

*Marks and Kind of Packages :Description of Goods		*Gross Weight	*Measurement	
Specify Currency	Declared Value for Customs	Declared Value for Carriage	Insurance Amount	Shipper's C.O.D
Special Instructions: Agree Rate:		We hereby guarantee payment of all freight collect charges due to the forwarders or to the carrier. If the shipment is abandoned ,refused by consignee. Returned at our request, confiscated by the customs or for any other reason can't be delivered within a reasonable time		
Documents accompanying Airway Bill: <input type="checkbox"/> Packing List <input type="checkbox"/> Certificate of Origin <input type="checkbox"/> Commercial Invoice <input type="checkbox"/> Consular Invoice		Signatory's Name in Block Letters:		
Received the above shipment for: By:		Signature and Stamp: Date: (Month/Day/Year)		

②

③

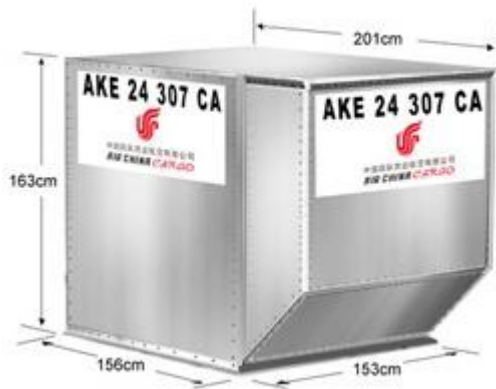

④

⑤

(2) 实施条件

	2	30
	1	30 60 0
	5	
	30	
	30	2

(3) 考核时量

60

(4) 评分细则

2 100
20% 80%
1
1

(20)	5		2	3
	5		2	3
	10		5	5

					0
(80)		20		2	
		5		5	10
		15			
		20			10 5
				10	

二、仓储与配送作业组织与管理模块

1. 2-1

1

50

40

() 20

1

2019 11 7

	/		
1	6956511900725		177
2	6939261900108		980
3	6932010062065		17
4	6932010061976		130
5	6932010061969		72
6	6932010061952		42
7	6932010061945		456
8	6932010061938		14
9	6932010061921		104
10	6932010061914		90
11	6932010061907	1+2	381
12	6932010061891		1018
13	6932010061884		890
14	6932010061877		81
15	6932010061860		1416
16	6932010061853		100
17	6932010061846		300



ABC

	%	0 A 15	15 B 45	45 C 100
	%	0 A 65	65 B 90	90 C 100

1 2

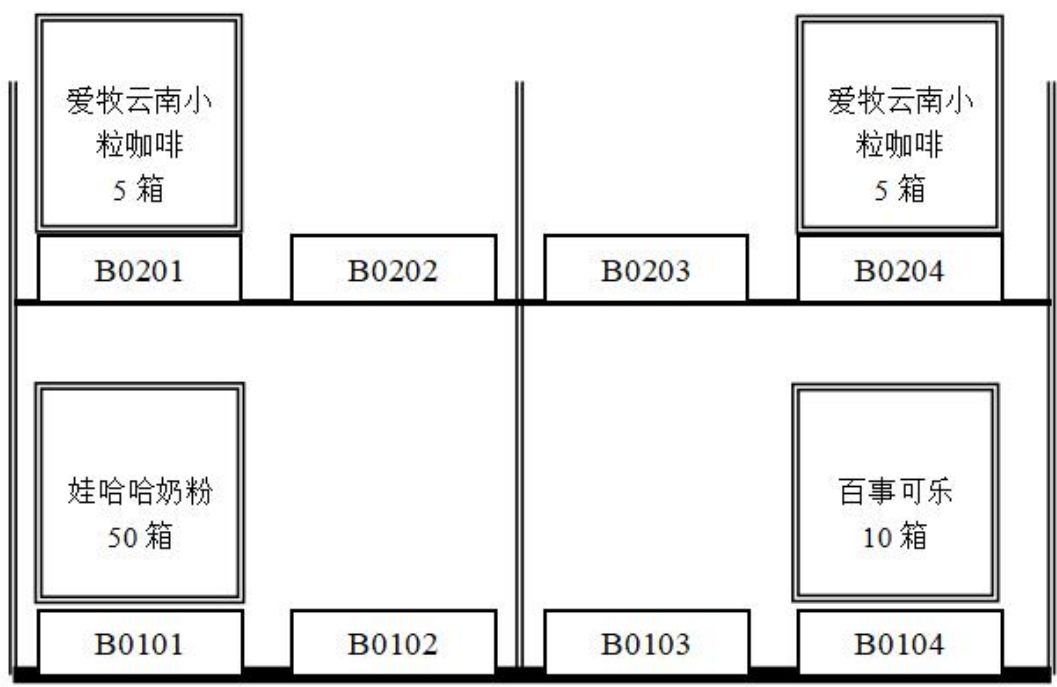
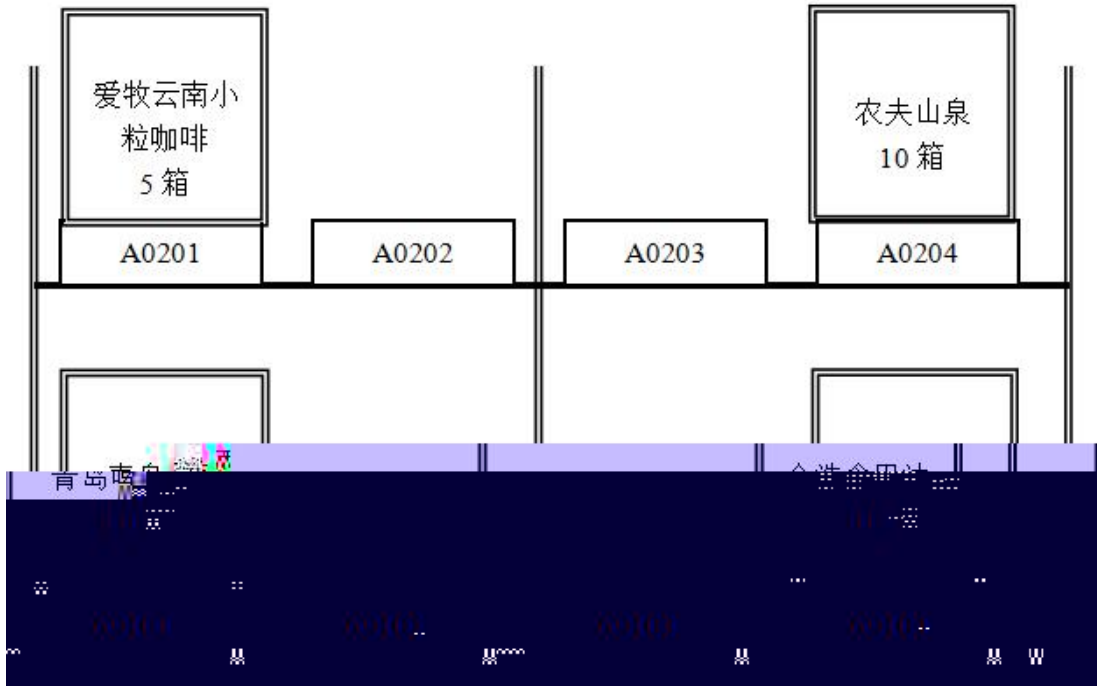

产品运输单

HD1011160001

No.	Name	Unit	Quantity	Specification	Weight	Volume	Remarks
1			50	100ml*5	50		
2	()		40	310ml	40		
3			20	100ml	20		

①

ABC

②

③

④

⑤

⑥

F

F

⑦

⑧

F

F

”

	1				
	2	2	2	2	1
			2		1
		1		1	F
	2		1		1
	1200	1000	144		10
			2		1

3

120

4

	5			2
				1
	10			2
				0
	5			2
				1
80	10	ABC		6
			ABC	4
	10			10
				1
	5			5
	5			3
			2	
	5			2
				3
			1	

	5		1 2 3	
	2	WMS	WMS 2	
	8		2 6 1	
	5		0.5 2 3	
	10		1 0.5 4 6 2 30mm	
	5	RF	RF 1	
	7		1 0.5 4 3 1 150mm	
	3	RF	RF 3	

2. 2-2

1

40 40 20

1

2019 9 7

	/		
			1456
			400
			2008
			1233
			476
			65
			32
			3724
			12433
			98
			3124
			1345
			300
			2080
			488
			986
			2036
			520
			20

			13000
			87
			54
			10000
			488
		1+2	212
			768
			21
			8945
			1178
			4024
			576
			656
			1421

ABC

	%	0 A 15	15 B 45	45 C 100
	%	0 A 60	60 B 90	90 C 100

1 2

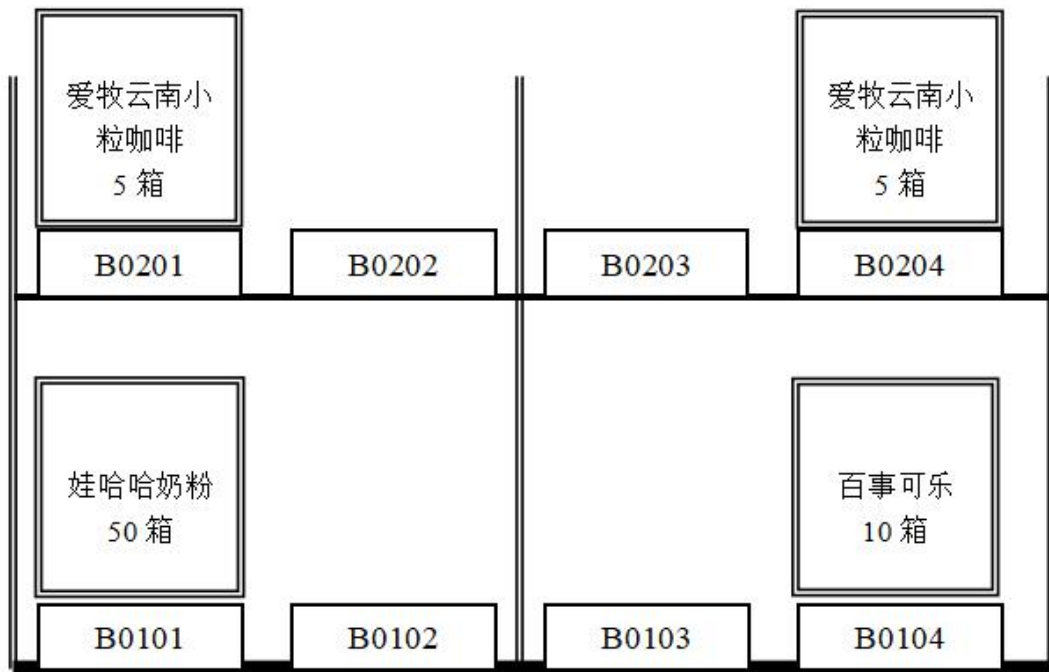
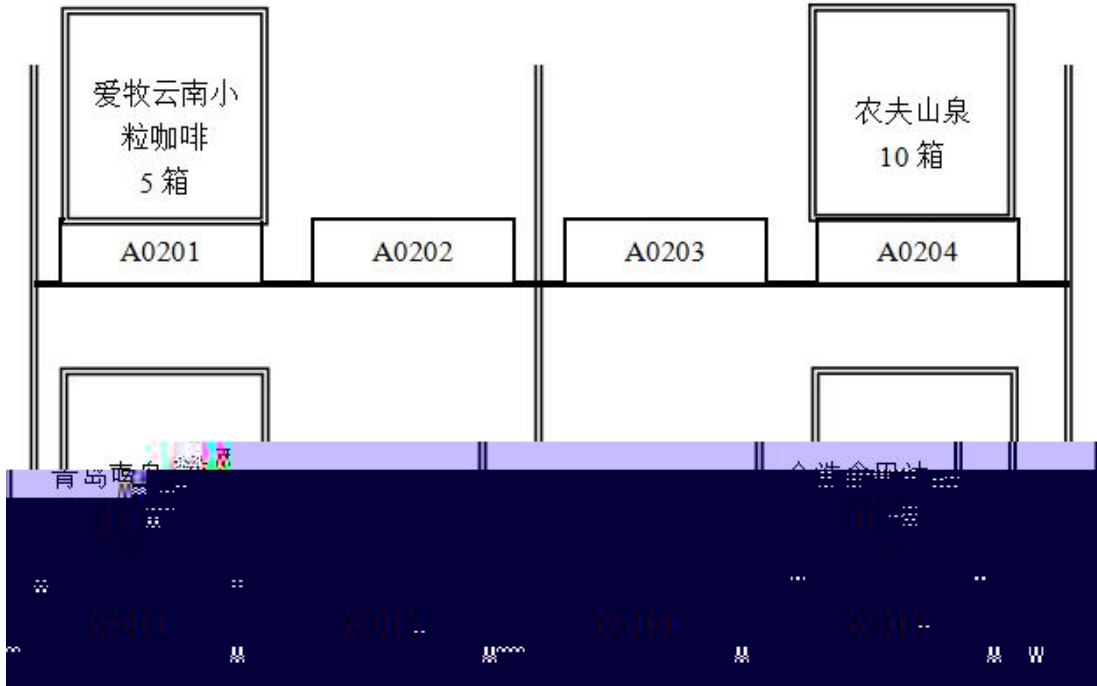

产品运输单

HD1011160001

1				310ml	40		
2			40		40		
3			20		20		

- ① ABC

- ②
- ③
- ④
- ⑤
- ⑥ F F
- ⑦
- ⑧ F F

2

	1	
	2 2 2 2	1 1

			2		1		1		1	
			1		1		F		2	
			2		1		1			
	1200	1000	144			10				
				2		1				

3

120

4

	5						2		1
						2			
	10						1		
						2			2
							1		
	5						2		
							2		1
	10	ABC							2
						6			
					ABC		4		
	10							10	3
							1		
	5						5		
								3	
	5					2			
							2		3
	5					1			
							2		
	5							3	
						1			
							2		
								3	

80

		2	WMS	WMS	2	
		8			6	1
					2	
		5			3	
				0.5	2	
		10			6	2
					4	
				1	0.5	
						30mm
		5	RF		RF	1
		7			3	1
					4	
				1	0.5	
						150mm
		3	RF		RF	3

3. 2-3

1

20

40

30

1

2020 1 7

	/		
1	6932010061884		5684
2	6932010061839		2624
3	6932010061891		2304
4	6932010061945		16096
5	6932010061808		4712
6	6932010061921		35780
7	6956511900725		84
8	6932010061952		3072
9	6917878001982	1+2	848
10	6932010061815		1952
11	6932010061907		40000
12	6918010061360		216
13	6932010061969		348
14	6921168509256		52000
15	6932010061938		80
16	6931528109163		2080
17	6932010061846		8144
18	6920855052068		3944
19	6932010061853		1952

20	6901521103123		8320
21	6903148042441		1200
22	6917878007441		5380
23	6920855784129		12496
24	6932010061860		392
25	4891599338393		5824
26	6918163010887		14896
27	6932010061877		128
28	6939261900108		260
29	6920907800173		1904
30	6932010062065		4932
31	6932010061976		8032
32	6901668054852		1600
33	6932010061822		49732

ABC

	%	0 A 15	15 B 45	45 C 100
	%	0 A 65	65 B 90	90 C 100

1 2

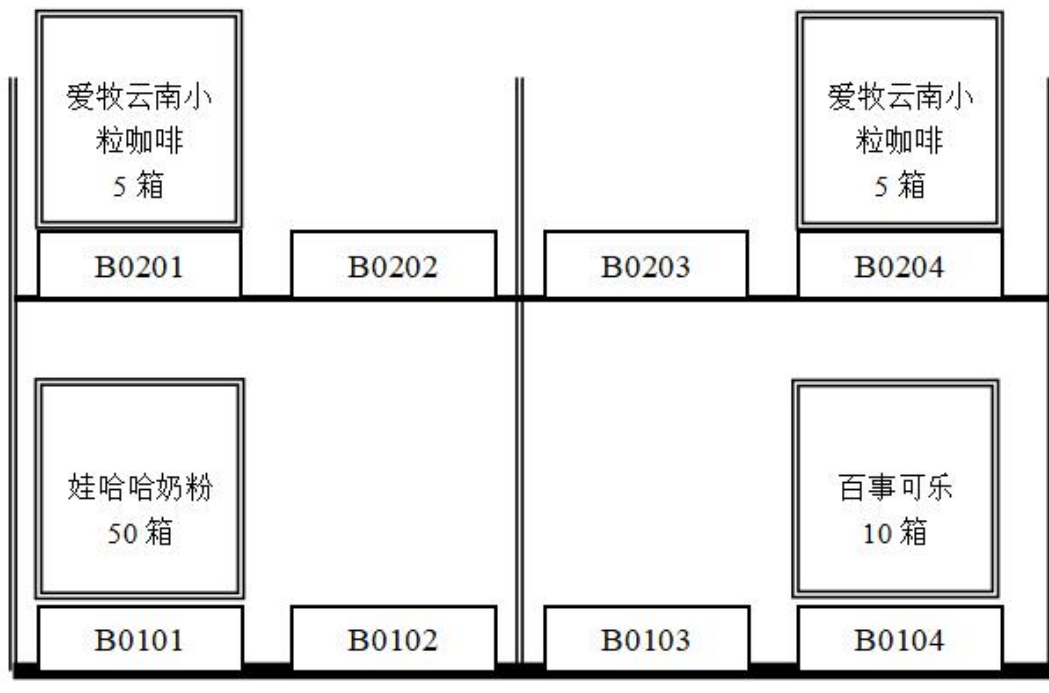
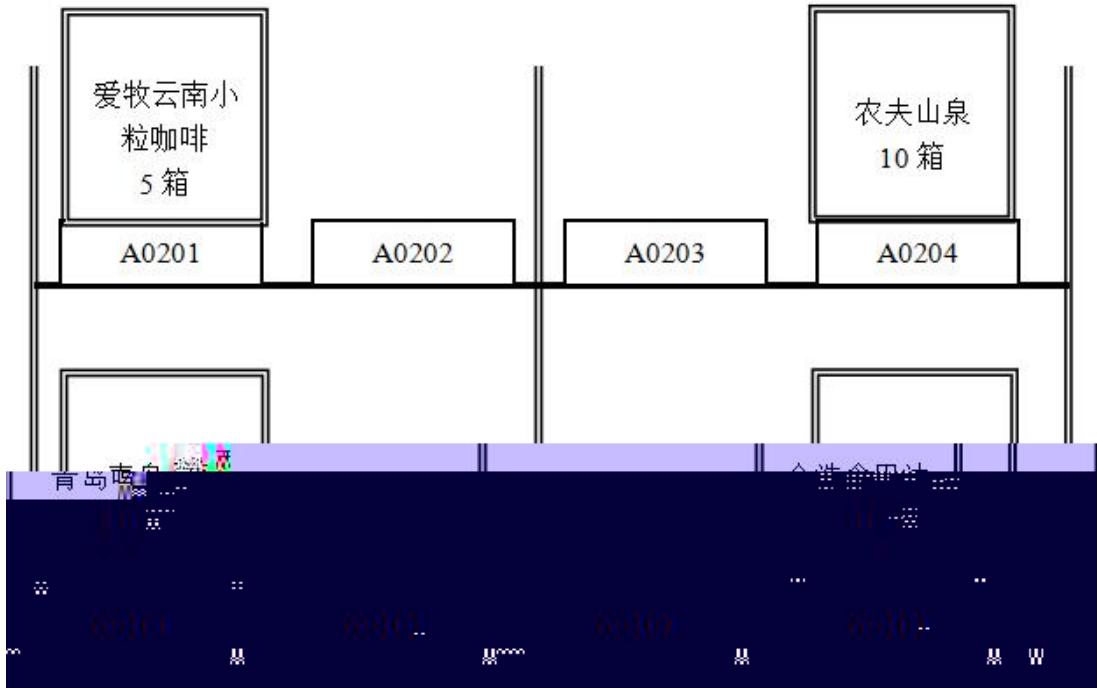

产品运输单

HD1011160001

1			20	100ml*5	20		
2			40	100ml	40		
3			40	330ml	30		

①

ABC

②

③

④

⑤

⑥

F

F

⑦

⑧

F

F

*

	1	1	1	F	2	
	2		1		1	
	1200	1000	144		10	
			2		1	

3

120

4

	5			2	1
				2	
	10			1	2
				2	
	5			2	1
				2	
80	10	ABC		6	2
			ABC	4	
	10			10	3
				1	
	5			5	
	5			3	
	5			2	3
			1		
5			2		
			1	3	

		2	WMS	WMS	2	
		8			6	1
					2	
		5			3	
				0.5	2	
		10			6	2
					4	
				1 0.5		30mm
		5	RF		RF	1
		7			3	1
					4	
				1 0.5		150mm
		3	RF		RF	3

4. 2-4

1

40

30

30

1

2020 2 7

	/		
1	6939261900108		54
2	6932010062065		421
3	6932010061976		432
4	6932010061976		6000
5	6932010061969		65
6	6932010061952		245
7	6932010061945		765
8	6932010061907		298
9	6932010061891		199
10	6932010061884		412
11	6932010061860		76
12	6932010061853		164
13	6932010061846		533
14	6932010061839		231
15	6932010061822		1994
16	6932010061815		176
17	6932010061808		267
18	6931528109163		187
19	6921168509256		2345

20	6920907800173		132
21	6920855784129		632
22	6920855052068		254
23	6918163010887		654
24	6918010061360		43
25	6917878007441		345
26	6917878001982	1+2	87
27	6903148042441		90
28	6901668054852		123
29	6901521103123		589
30	4891599338393		2003

ABC

	%	0 A 15	15 B 40	40 C 100
	%	0 A 65	65 B 85	85 C 100

1 2

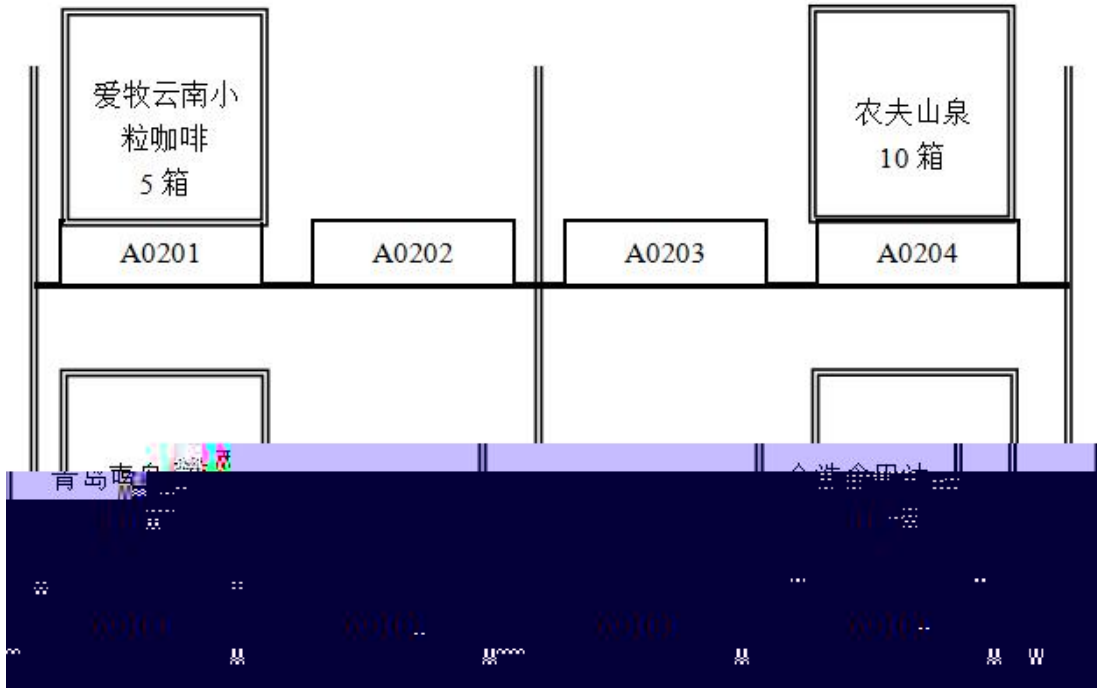

	2	1	1	1	
	1	1	1	F	2
	2		1	1	
	1200	1000	144	10	
			2	1	

3

120

4

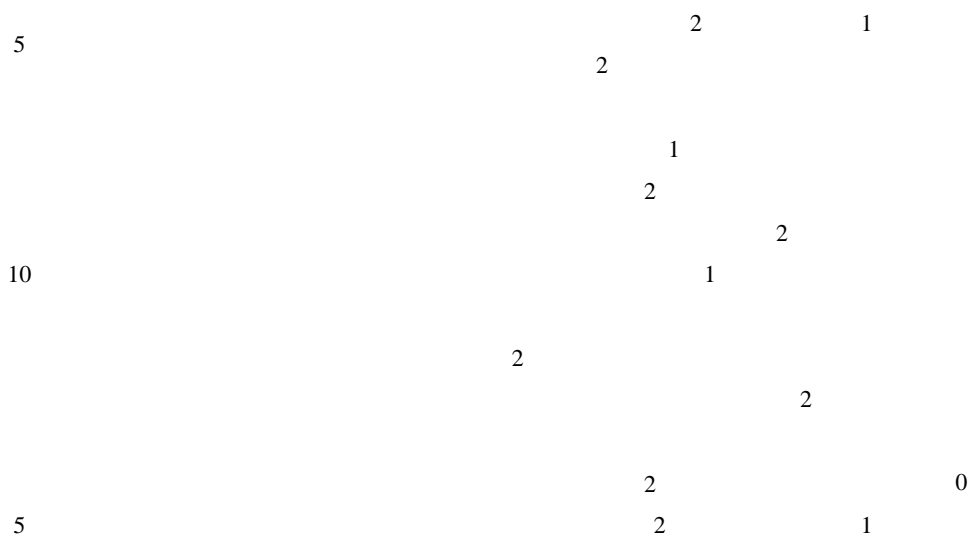

		2	WMS	WMS	2	
		8			6	1
					2	
		5			3	
				0.5	2	
		10			6	2
					4	
				1	0.5	
						30mm
		5	RF		RF	1
		7			3	1
					4	
				1	0.5	
						150mm
		3	RF		RF	3

5. 2-5

1

40

40

20

1

2020 4 7

	/		
1	6932010061884		825
2	6932010061839		463
3	6932010061891		399
4	6932010061945		1531
5	6932010061976		865
6	6932010061808		535
7	6932010061952		491
8	6917878001982	1+2	175
9	6932010061815		353
10	6918010061360		87
11	6932010061969		131
12	6921168509256		3989
13	6931528109163		375
14	6932010061846		1067
15	6920855052068		509
16	6932010061853		329
17	6901521103123		1179
18	6903148042441		181

19	6917878007441		691
20	6920855784129		1265
21	6932010061860		153
22	4891599338393		4007
23	6918163010887		1309
24	6939261900108		109
25	6920907800173		265
26	6932010062065		12001
27	6932010061907		597
28	6932010061976		4691
29	6901668054852		247
30	6932010061822		843

ABC

	%	0 A 15	15 B 40	40 C 100
	%	0 A 65	65 B 85	85 C 100

1 2

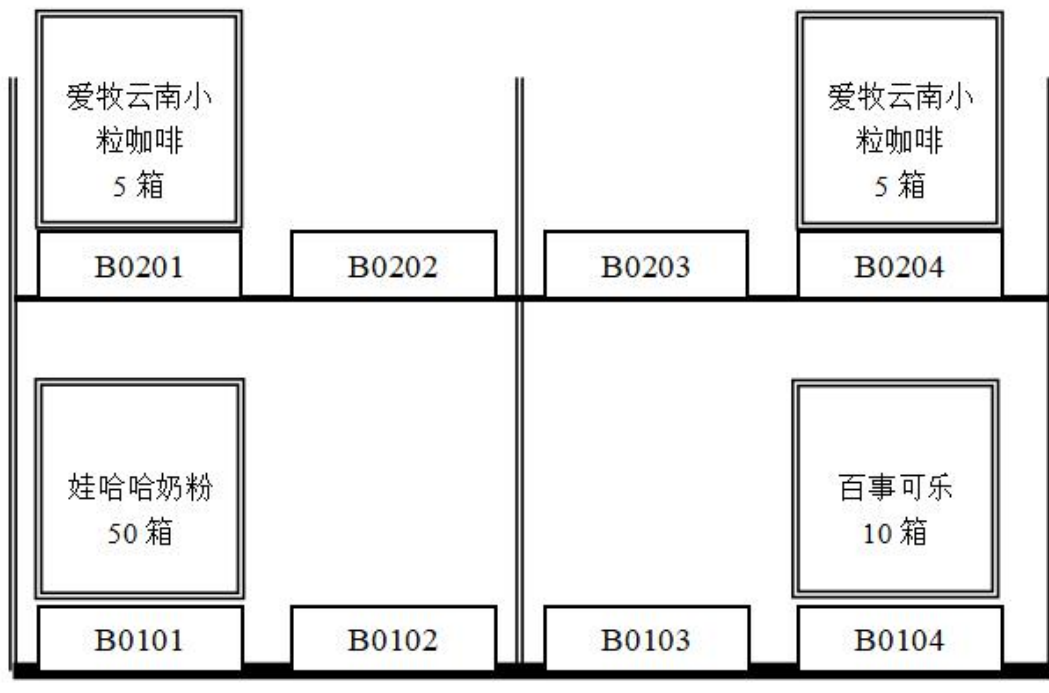
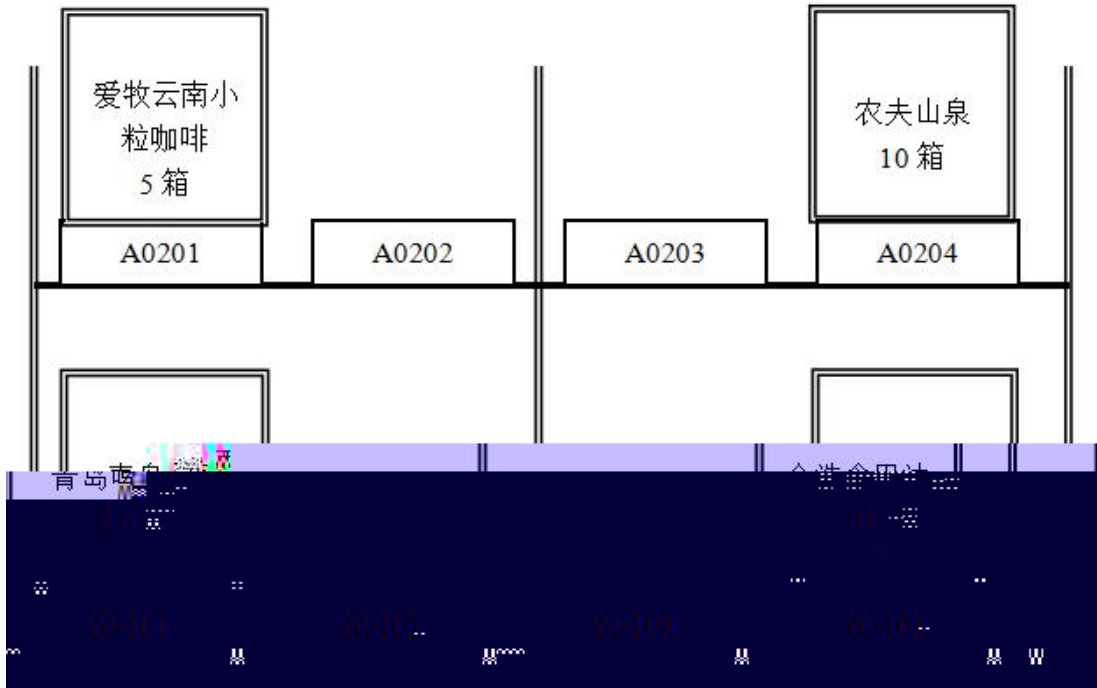

产品运输单

D1011160001

1	()		40	310ml	40		
2				330ml	40		
3			20	100ml	20		

2

①

ABC

②

③

④

⑤

4040 Q4i-D S \$

			2		1		1		1	
			1		1		F		2	
			2		1		1			
	1200	1000	144			10				
				2		1				

3

120

4

	5						2		1
						2			
	10						1		
						2			2
							1		
	5						2		
							2		1
	10	ABC							2
						6			
	10				ABC		4		
								10	3
	5						1		
								5	
	5								3
						2			
	5						2		3
						1			
	5						2		
									3
80						1			
							2		
									3

	2	WMS	WMS	2	
	8			6	1
				2	
	5			3	
			0.5	2	
	10			6	2
				4	
			1 0.5		30mm
	5	RF		RF	1
	7			3	1
				4	
			1 0.5		150mm
	3	RF		RF	3

6. 2-6

1

() 20

50

40

2019 11 7

	/	
1	6932010061938	41
2	6932010062065	50
3	6932010061952	125
4	6901668054852	188
5	6920855052068	209
6	6932010061969	215
7	6917878001982	221
8	6932010061877	242
9	6932010061914	269
10	6903148042441	290
11	6932010061853	299
12	6932010061921	311
13	6918010061360	329
14	6932010061976	389
15	6956511900725	530
16	6917878007441	599
17	6920855784129	

32	6921168509256		6631
33	6920907800173		3001
34	6918163010887		9766
35	6902774003017		16429

ABC

% 0 A C

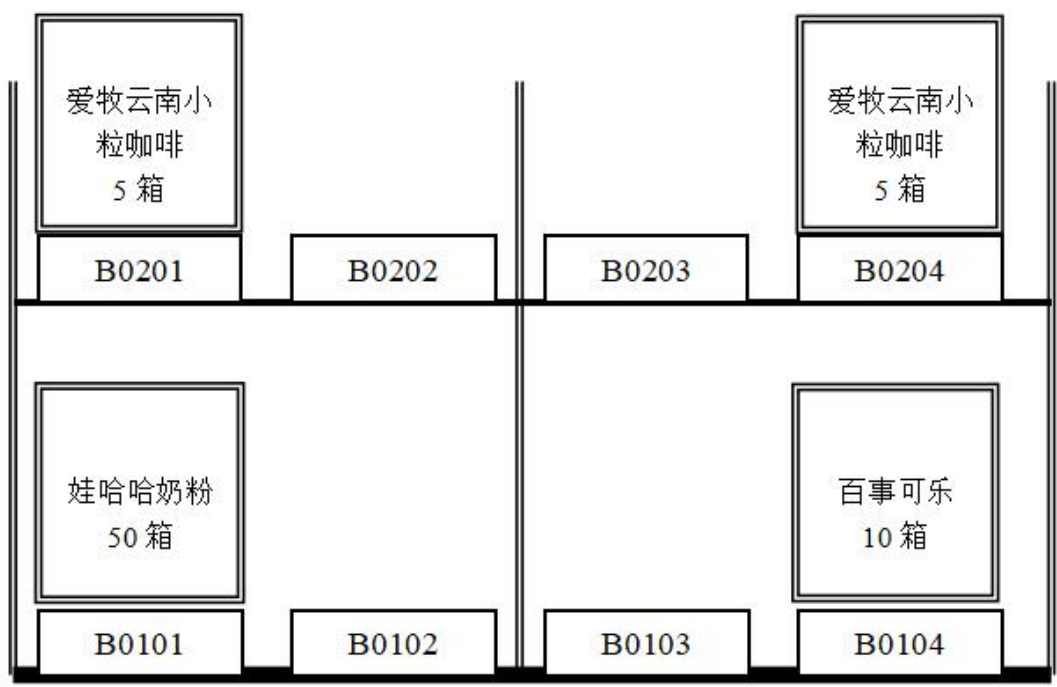
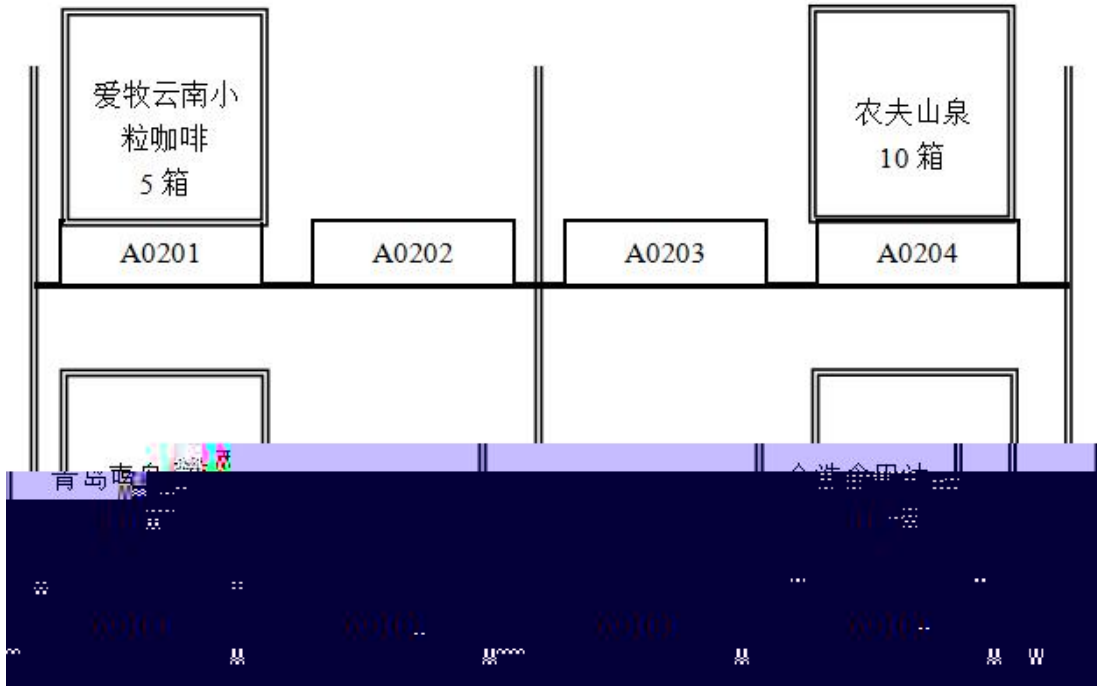

产品运输单

			2		1		1		1	
			1		1		F		2	
			2		1		1			
	1200	1000	144			10				
				2		1				

3

120

4

	5						2		1
						2			
	10						1		
						2			2
							1		
	5						2		
							2		1
	5								0
	10	ABC							2
						6			
					ABC		4		
	10							10	3
							1		
	5							5	
									3
	5					2			
							2		3
	5					1			
							2		
	5								3
						1			
							2		
									3

		2	WMS	WMS	2	
		8			6	1
					2	
		5			3	
				0.5	2	
		10			6	2
					4	
				1	0.5	
						30mm
		5	RF		RF	1
		7			3	1
					4	
				1	0.5	
						150mm
		3	RF		RF	3

7. 2-7

1

40 40 20

1

2019 9 7

	/		
1	6939261900108		51
2	6932010062065		5997
3	6932010061976		2342
4	6932010061976		429
5	6932010061969		62
6	6932010061952		242
7	6932010061945		762
8	6932010061907		1991
9	6932010061907		295
10	6932010061891		196
11	6932010061884		409
12	6932010061860		73
13	6932010061853		161
14	6932010061846		530
15	6932010061839		228
16	6932010061822		418
17	6932010061815		173
18	6932010061808		264
19	6931528109163		184

20	6920907800173		129
21	6920855784129		629
22	6920855052068		251
23	6918163010887		651
24	6918010061360		40
25	6917878007441		342
26	6917878001982	1+2	84
27	6903148042441		87
28	6901668054852		120
29	6901521103123		586
30	4891599338393		2000

ABC

%	0 A 15	15 B 40	40 C 100
%	0 A 65	65 B 85	85 C 100

1 2

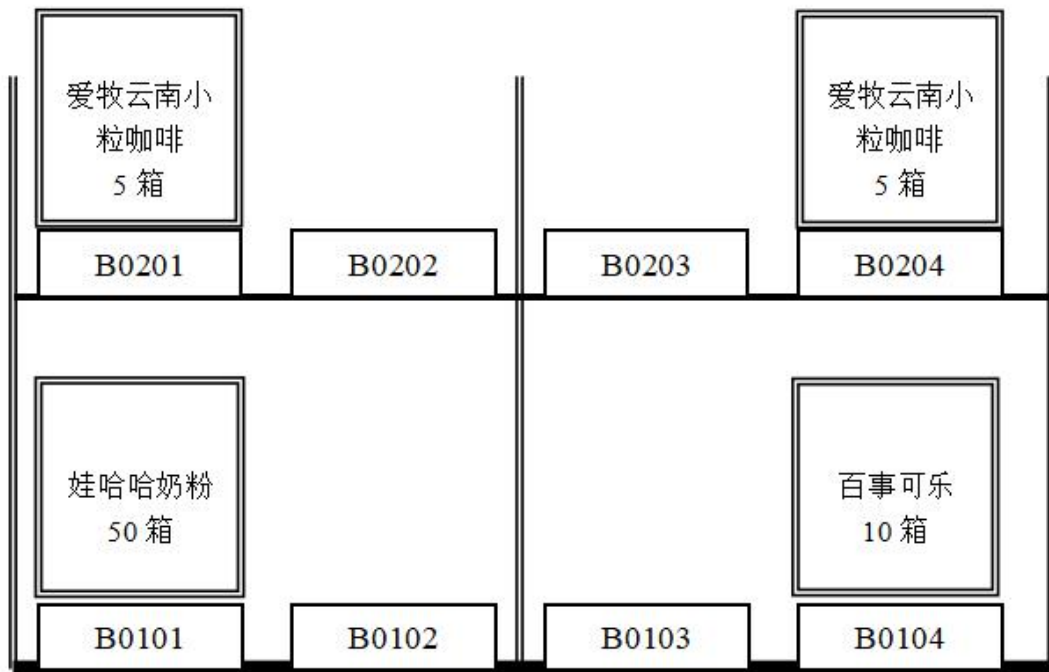
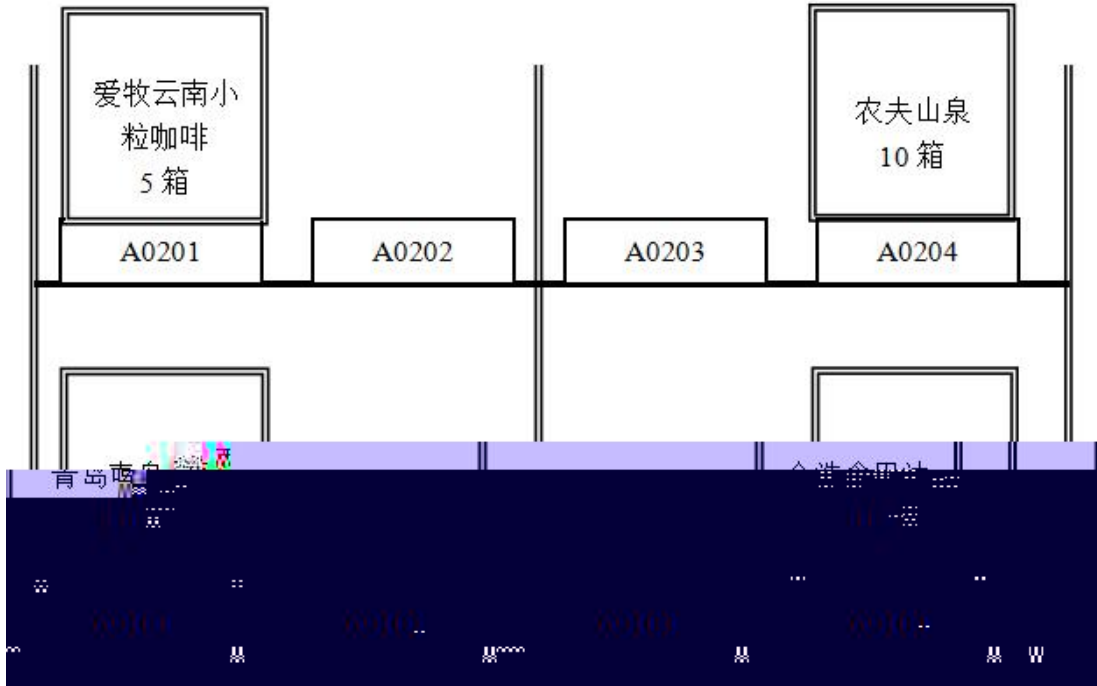

产品运输单

HD1011160001

1				310ml	40		
2			40		40		
3			20		20		

①

ABC

②

③

④

⑤

⑥

F

F

⑦

⑧

F

F

2

	1						
	2	2	2	2	1	1	

			2		1		1		1	
			1		1		F		2	
			2		1		1			
	1200	1000	144			10				
				2		1				

3

120

4

		5					2		1
						2			
		10					1		
						2		2	
							1		
					2				
		5					2		0
							2		
		5					2		1
		10	ABC						2
						6			
					ABC		4		
		10						10	3
							1		
		5						5	
									3
		5					2		
								2	3
		5				1			
								2	
		5							3
							1		
								2	
									3

		2	WMS	WMS	2	
		8			6	1
					2	
		5			3	
				0.5	2	
		10			6	2
					4	
				1	0.5	
						30mm
		5	RF		RF	1
		7			3	1
					4	
				1	0.5	
						150mm
		3	RF		RF	3

8. 2-8

1

20

40

30

1

2019 7 7

	/		
1	6956511900725		344
2	6939261900108		1950
3	6932010062065		24
4	6932010061976		250
5	6932010061969		134
6	6932010061952		74
7	6932010061945		902
8	6932010061938		18
9	6932010061921		198
10	6932010061914		170
11	6932010061907		6500
12	6932010061907	1+2	752
13	6932010061891		2026
14	6932010061884		1770
15	6932010061877		152
16	6932010061860		2822
17	6932010061853		190
18	6932010061846		590
19	6932010061839		1350

20	6932010061822		6190
21	6932010061822		530
22	6932010061815		510
23	6932010061808		862
24	6931528109163		990
25	6921168509256		4410
26	6920907800173		1990
27	6920855784129		470
28	6920855052068		130
29	6918010061360		210
30	6917878007441		390
31	6917878001982		138
32	6903148042441		184
33	6902774003017		10942
34	6901668054852		116
35	6901521103123		1400

ABC

	%	0 A 15	15 B 45	45 C 100
	%	0 A 65	65 B 90	90 C 100

1 2

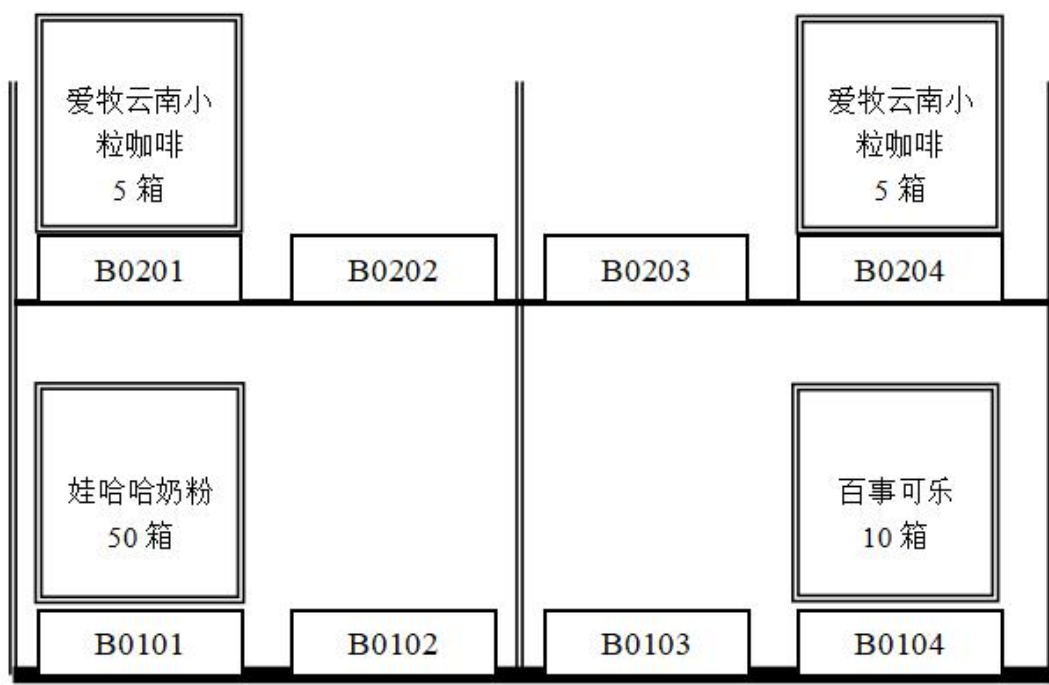
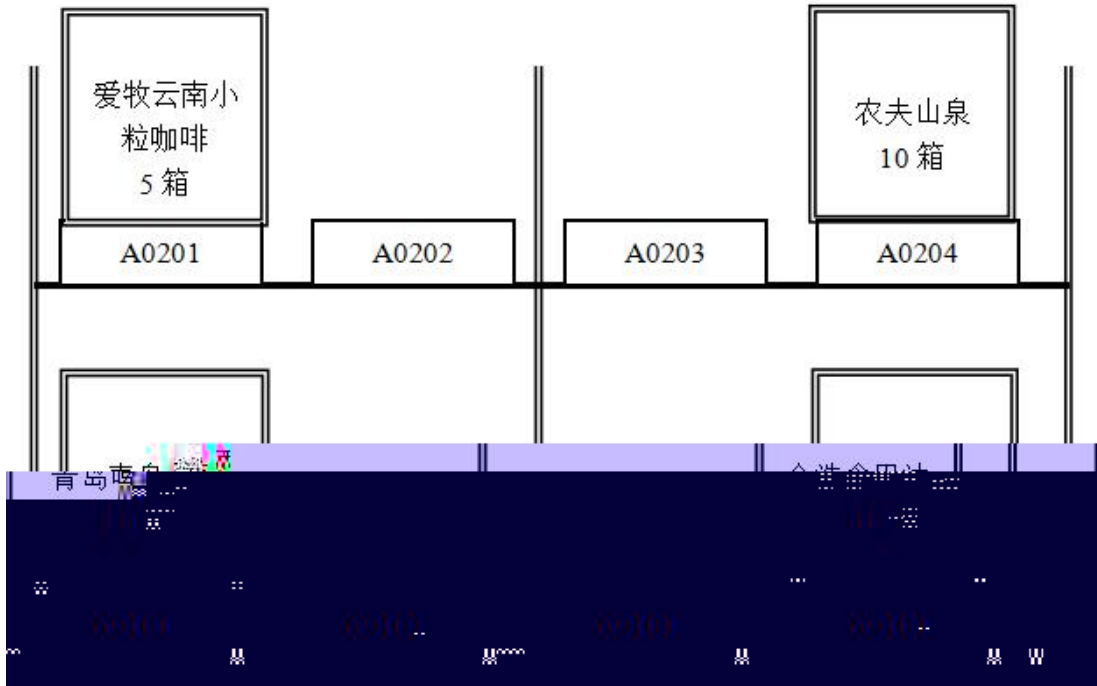

产品运输单

HD1011160001

1			20	100ml*5	20		
2			40	100ml	40		
3			40	330ml	30		

- ① ABC
- ②
- ③
- ④
- ⑤
- ⑥ F F
- ⑦
- ⑧ F F

2

	1	
	2 2 2 2 1 1	
	2 1 1 1	

	1	1	1	F	2	
	2		1		1	
	1200	1000	144		10	
			2		1	

3

120

4

	5			2	1
				2	
	10			1	
80				2	
	10	ABC		6	2
			ABC	4	
	10			10	3
				1	
	5			5	
				3	
5			2	3	
			1		
5			2		
			1	3	

		2	WMS	WMS	2	
		8			6	1
					2	
		5			3	
				0.5	2	
		10			6	2
					4	
				1	0.5	
						30mm
		5	RF	RF		1
					3	1
		7			4	
				1	0.5	
						150mm
		3	RF		RF	3

9. 2-9

1

40

30

30

1

2019 8 7

	/		
1	4891599338393		7564
2	6901521103123		2000
3	6901668054852		284
4	6903148042441		280
5	6917878001982	1+2	256
6	6917878007441		729
7	6918010061360		54
8	6918163010887		2300
9	6920855052068		421
10	6920855784129		2100
11	6920907800173		321
12	6921168509256		8000
13	6931528109163		375
14	6932010061808		422
15	6932010061815		367
16	6932010061822		954
17	6932010061839		400
18	6932010061846		1987
19	6932010061853		345

20	6932010061860		210
21	6932010061877		45
22	6932010061884		897
23	6932010061891		389
24	6932010061907		5321
25	6932010061921		1521
26	6932010061938		11
27	6932010061945		2345
28	6932010061952		411
29	6932010061969		204
30	6932010061976		5000
31	6932010062065		626
32	6939261900108		66
33	6956511900725		23

ABC

	%	0 A 15	15 B 45	45 C 100
	%	0 A 60	60 B 90	90 C 100

1 2

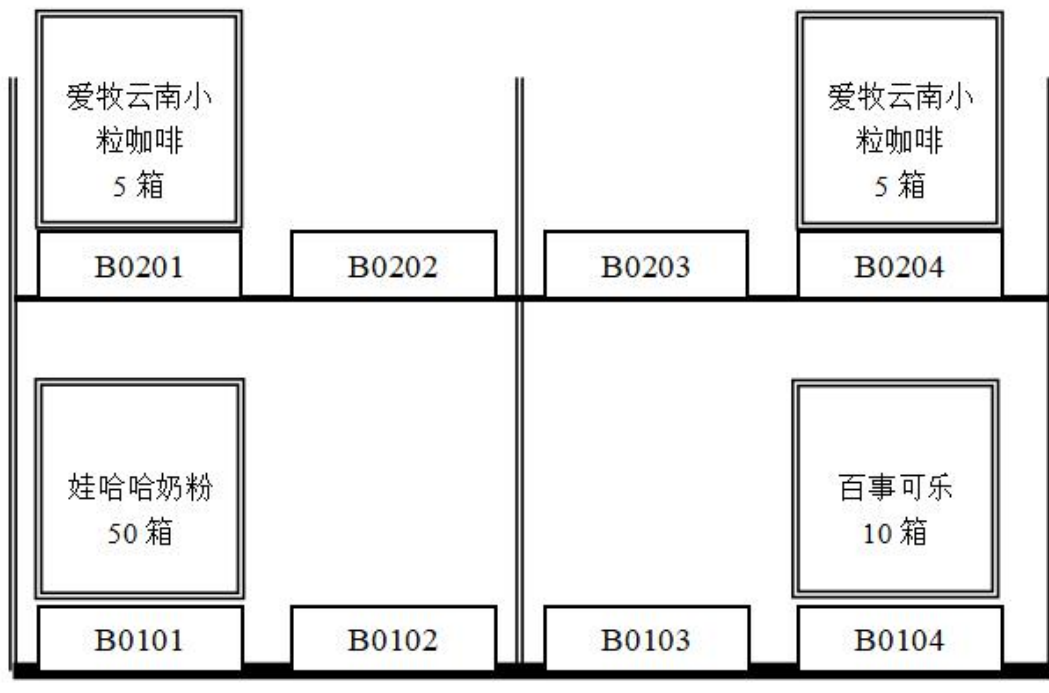
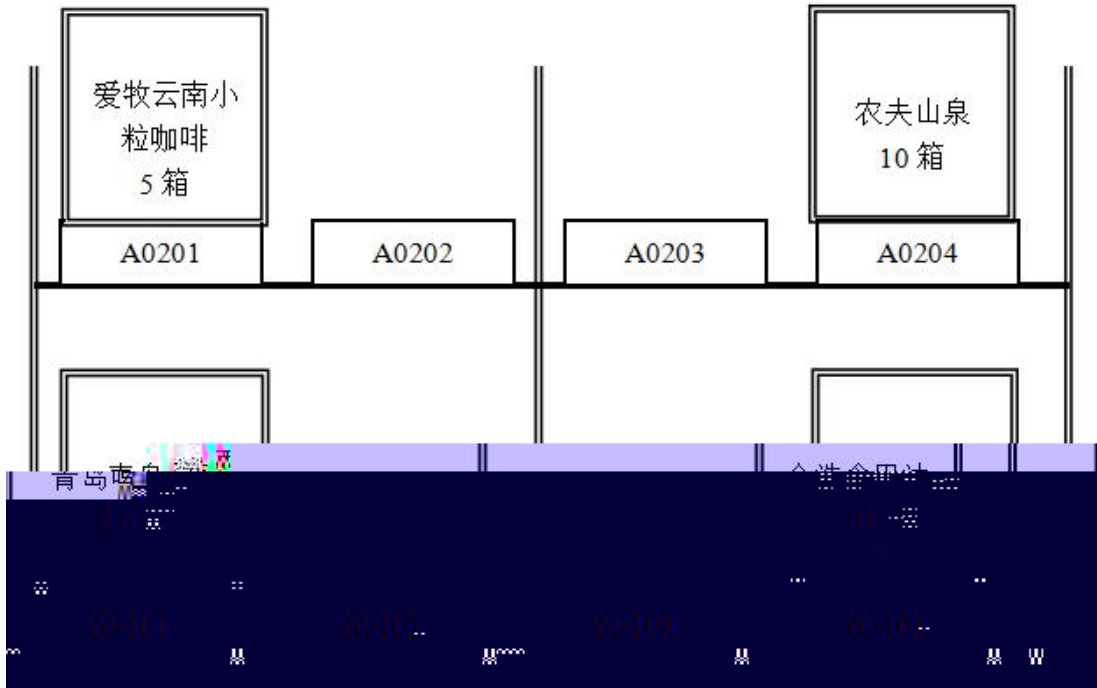

产品运输单

HD1011160001

1			40	330ml	40		
2			30	100ml*5	30		
3			30	310ml	30		

①

ABC

②

③

④

⑤

⑥

F

F

⑦

⑧

F

F

2

	1				
	2	2	2	2	1
					1

			2		1		1		1	
			1		1		F		2	
			2		1		1			
	1200	1000	144			10				
				2		1				

3

120

4

		5					2		1
						2			
		10					1		
						2			
							2		
		5					2		0
							2		
		5					2		
		10	ABC				6		2
						ABC		4	
		10						10	3
							1		
		5					5		
								3	
		5					2		
							2		3
		5					1		
							2		
		5						3	
							1		
							2		
								3	

		2	WMS	WMS	2	
		8			6	1
					2	
		5			3	
				0.5	2	
		10			6	2
					4	
				1	0.5	
						30mm
		5	RF		RF	1
		7			3	1
					4	
				1	0.5	
						150mm
		3	RF		RF	3

10. 2-10

1

40

40

20

1

2019 10 7

	/		
1	6932010061822		2862
2	6901668054852		852
3	6932010061976		15000
4	6932010062065		1878
5	6920907800173		963
6	6939261900108		198
7	6932010061877		135
8	6918163010887		6900
9	4891599338393		22692
10	6932010061860		630
11	6920855784129		6300
12	6917878007441		2187
13	6903148042441		840
14	6901521103123		6000
15	6932010061853		1035
16	6920855052068		1263
17	6932010061846		5961

18	6931528109163		1125
19	6932010061938		33
20	6921168509256		24000
21	6932010061969		612
22	6918010061360		162
23	6932010061907		15963
24	6932010061815		1101
25	6917878001982	1+2	768
26	6932010061952		1233
27	6956511900725		69
28	6932010061921	9 62	

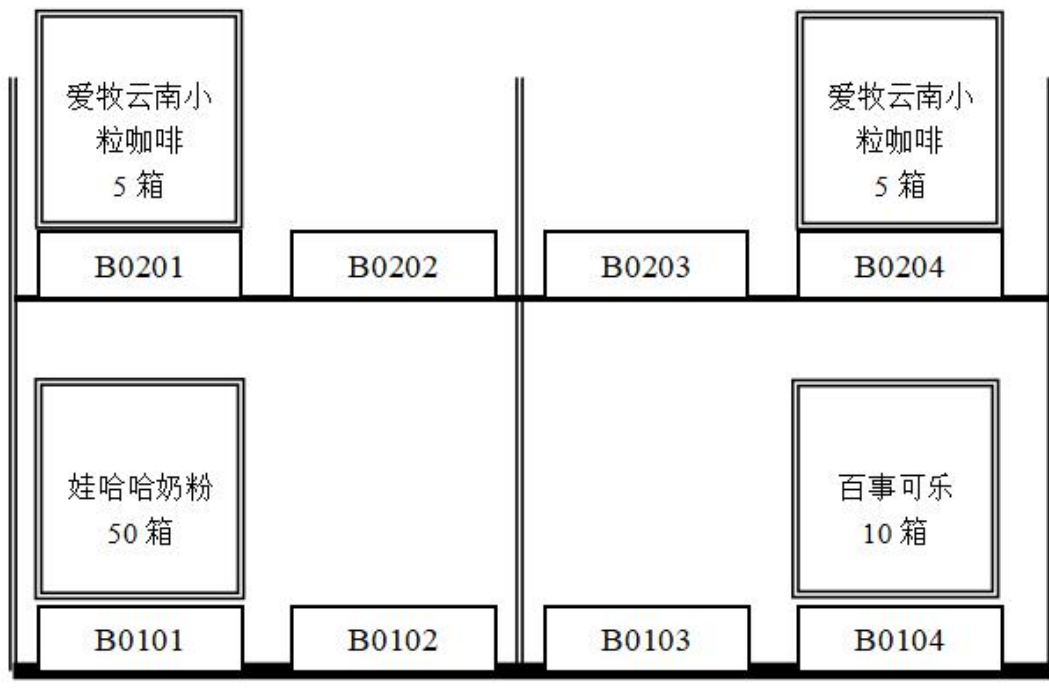
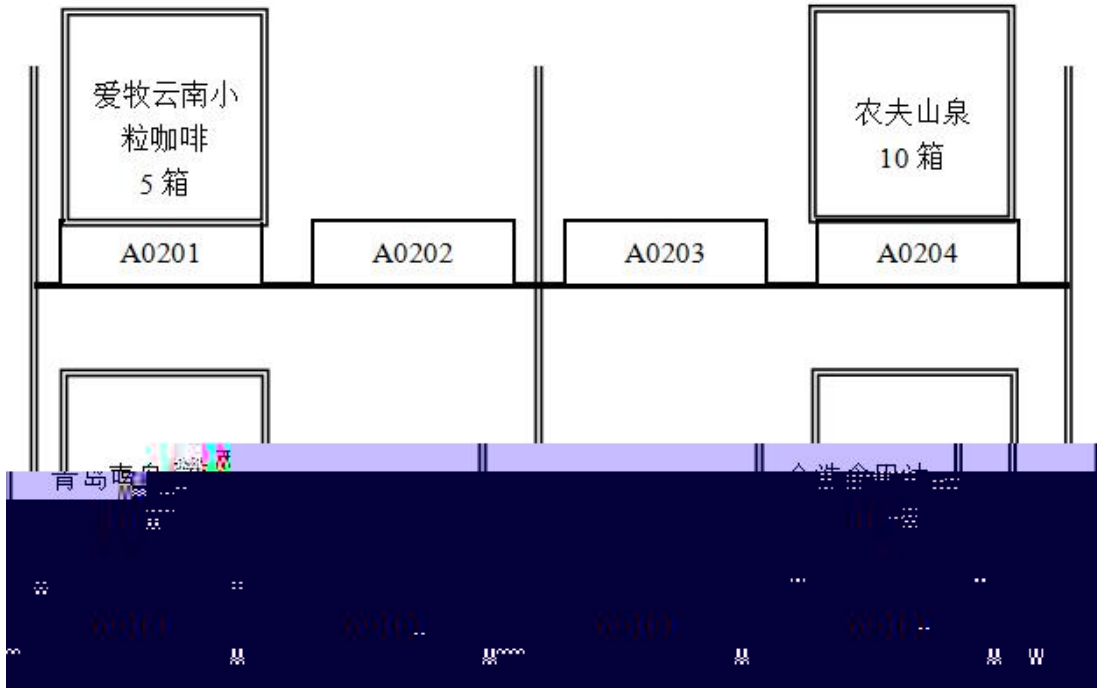

产品运输单

HD1011160001

1	()		40	310ml	40		
2			40	330ml	40		
3			20	100ml	20		

- ① ABC

- ②
- ③
- ④
- ⑤
- ⑥ F F
- ⑦
- ⑧ F F

2

	1	
	2 2 2 2 1 1	

			2		1		1		1	
			1		1		F		2	
			2		1		1			
	1200	1000	144			10				
				2		1				

3

120

4

		5					2		1
						2			
		10					1		
						2			2
							1		
						2			
		5					2		1
							2		
		10	ABC						2
						6			
					ABC		4		
		10						10	3
							1		
		5						5	
									3
		5					2		
								2	3
		5				1			
								2	
		5							3
						1			
								2	
									3

		2	WMS	WMS	2	
		8			6	1
					2	
		5			3	
				0.5	2	
		10			6	2
					4	
				1	0.5	
						30mm
		5	RF		RF	1
		7			3	1
					4	
				1	0.5	
						150mm
		3	RF		RF	3

11. 2-11

1

①

			()		
1			2	3	
2			298	4	
3			5	2	
		---	---		

			()		
1			2	2	
2			298	5	
		---	---		

			()		
1			2	2	
2			298	6	
3			5	1	
		---	---		

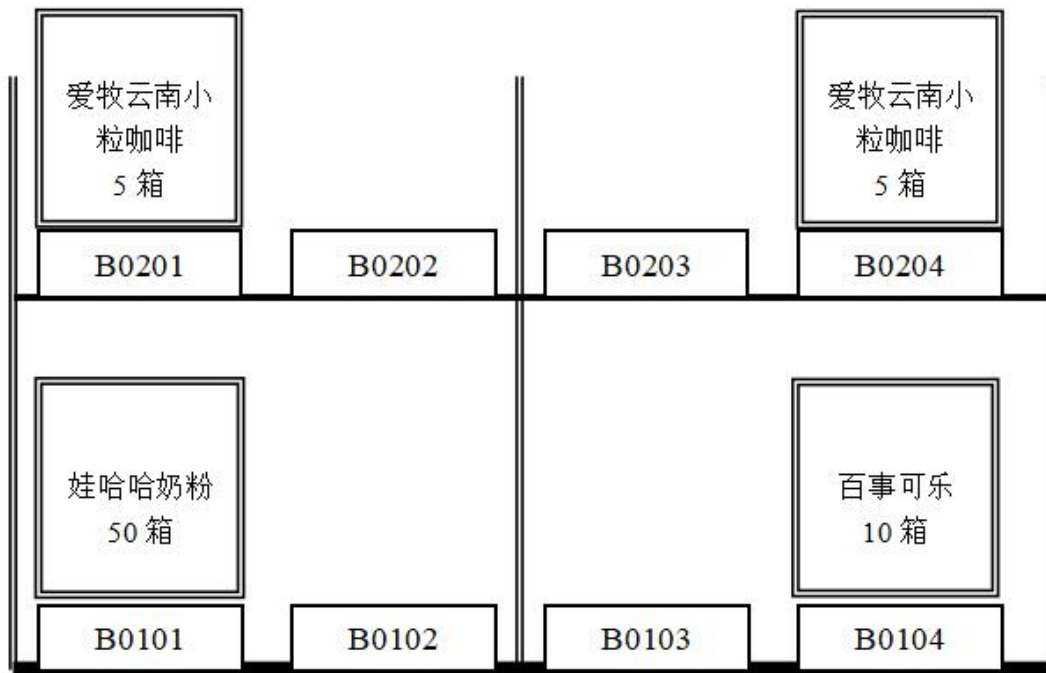
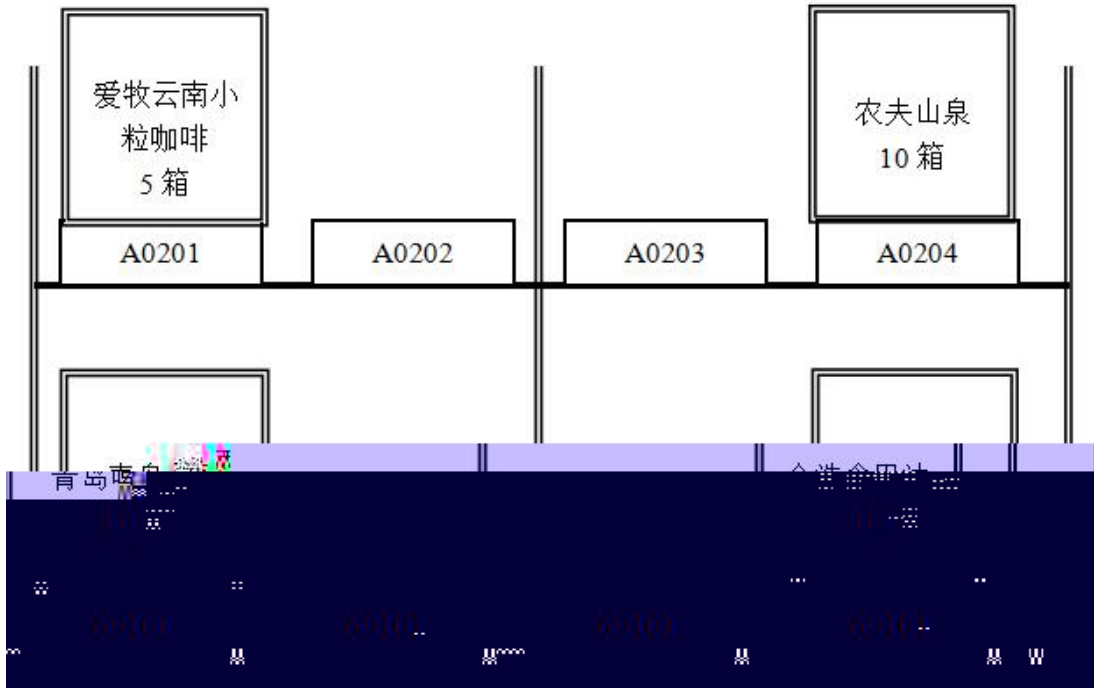

. M
.

-
-
-
-
-

F

①

km

②

	1200 1000 144	10	10	
		2	1	

3

120

4

				3	
		10		6	2
		10	M	3	2
30		20		10	5
		10		6	4

12. 2-12

1

D

D

			()		
1			2	3	
2			298	5	
3			3	1	

		---	---		
--	--	-----	-----	--	--

			()		
1			2	3	
2			298	6	
3			3	2	
		---	---		

			()		
1			2	4	
2			298	1	
3			3	4	
		---	---		

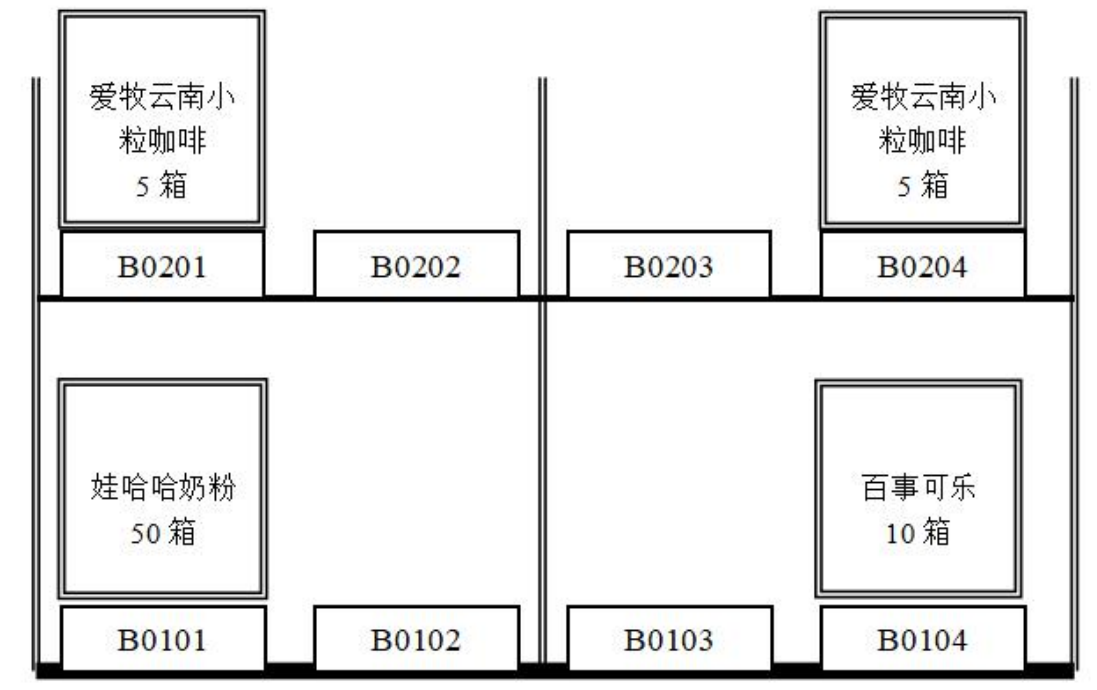
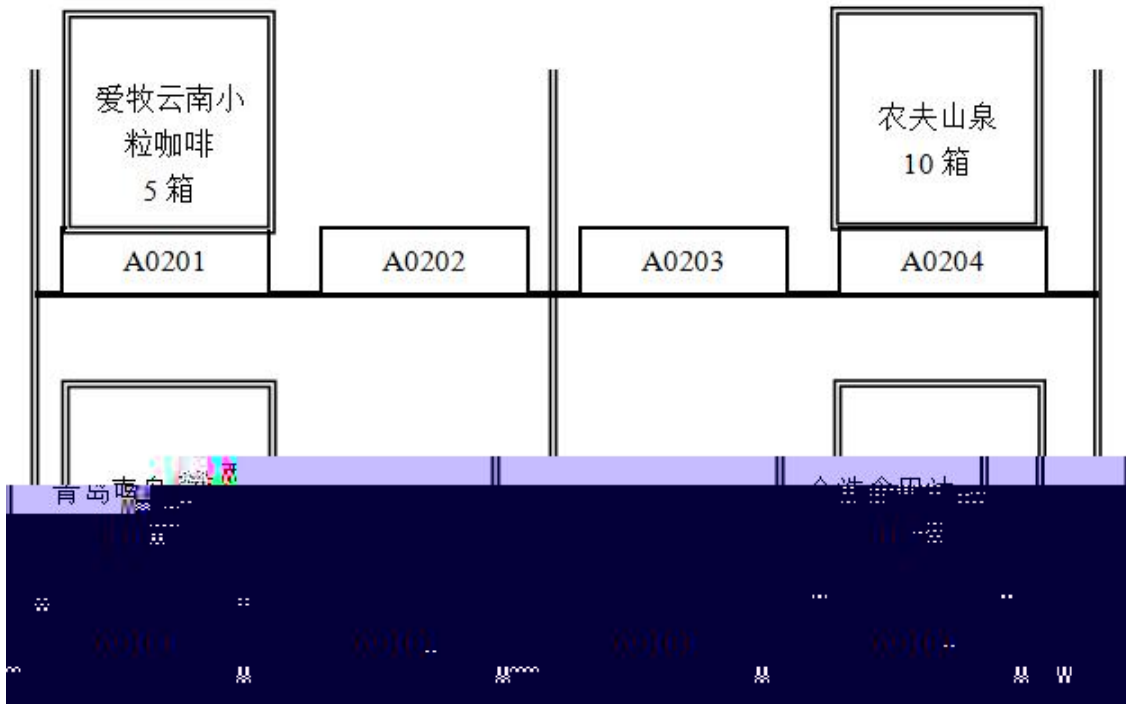

. M

.
. .
. .
. .
. .
. .

F

①

km

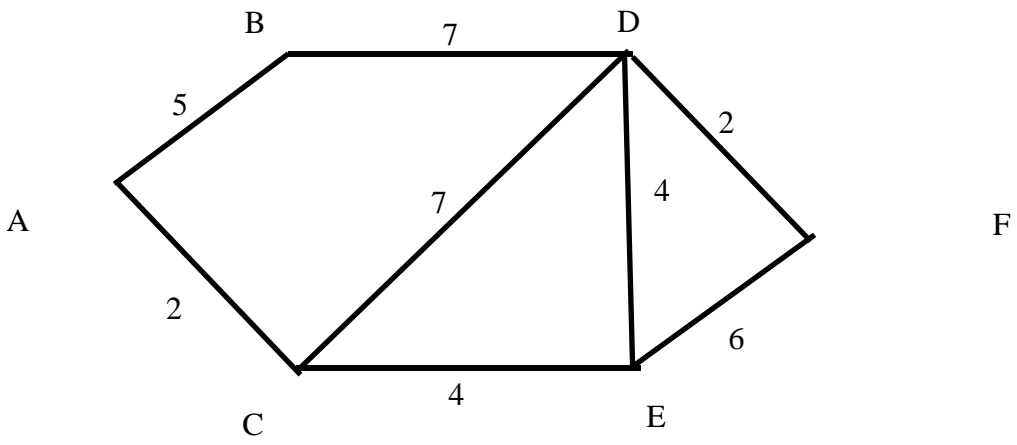

②

2

	1	
	2 2 2 2 1 1 2 1 1 1 1 1 F 2 2 1 1	
	1200 1000 144 10 10	
	2 1	

3

120

4

	5		1 2 2	
	10		1 2 2 2 1 2	
	5		1 2 2	0
	5		5	
	5	M	1 2 2 1	
	5	M	4 1	

			()		
1			60	2	
2			298	2	
3			3	1	
		---	---		

			()		
1			298	3	
2			3	1	
		---	---		

			()		
1			60	3	
2			298	3	
3			3	1	
		---	---		

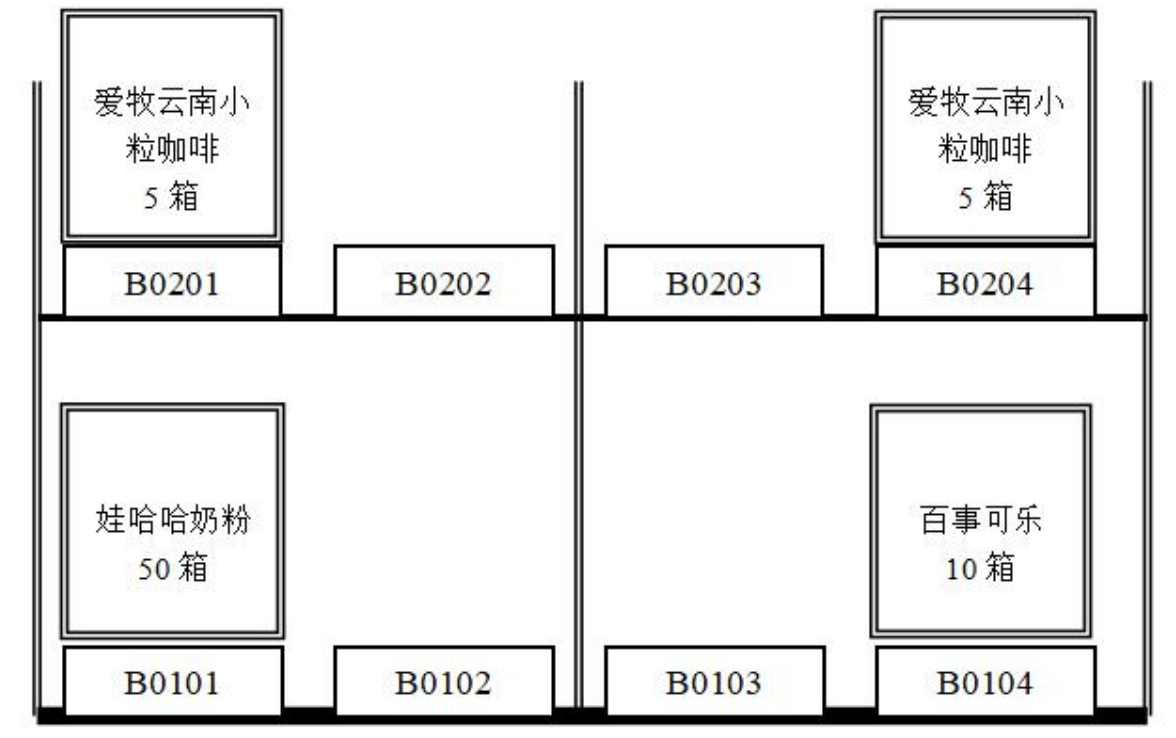
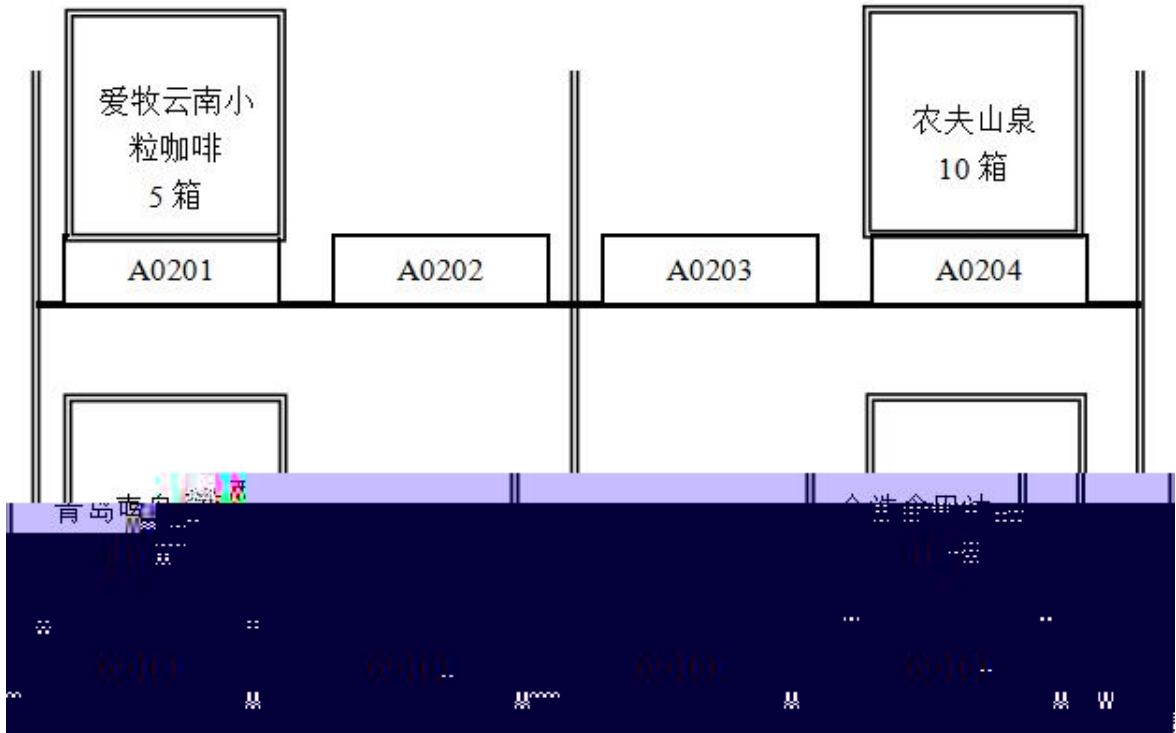

. M

.
. .
. .
. .
. .
. .

F

①
km

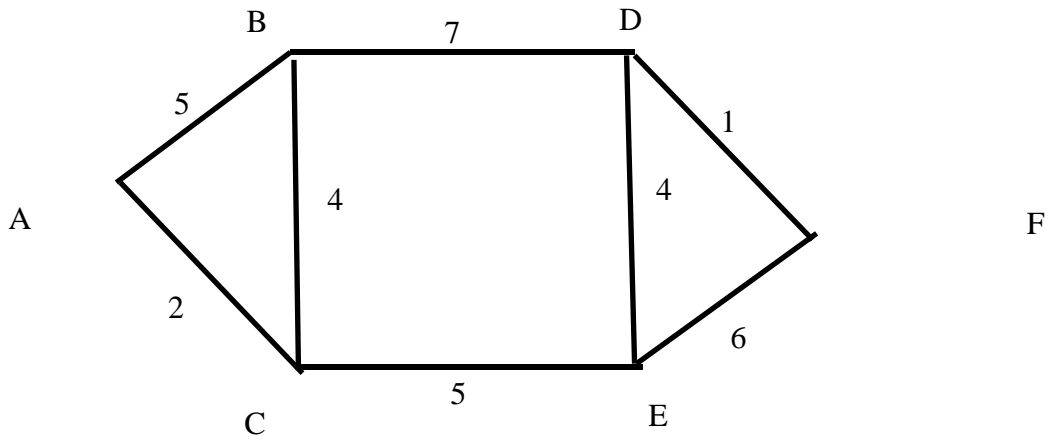

②

3

2

	1							
	2	2	2	2		1		1
			2		1		1	1
		1		1	1	F	2	
	2			1		1		
	1200	1000	144		10		10	
			2		1			

3

120

4

	5			1	2 2
	10				1 2 2 1 2
	5			1	2 2 0
	5				5

50	5	M	1 2
			2 1
	5	M M	4 1
	15	(F) (F)	2 2 1 3 3 F 3
	10		2 2 6 2
10	M	2 3 2	
30	20		10 5 5
	10		4 3 3

14. 2-14

1

1

			()		
1			60	2	
2			298	3	
3			3	3	
		---	----		

			()		
1			60	2	
2			298	3	
		---	----		

		()	
1		60	1
2		298	4
3		3	2
		---	----

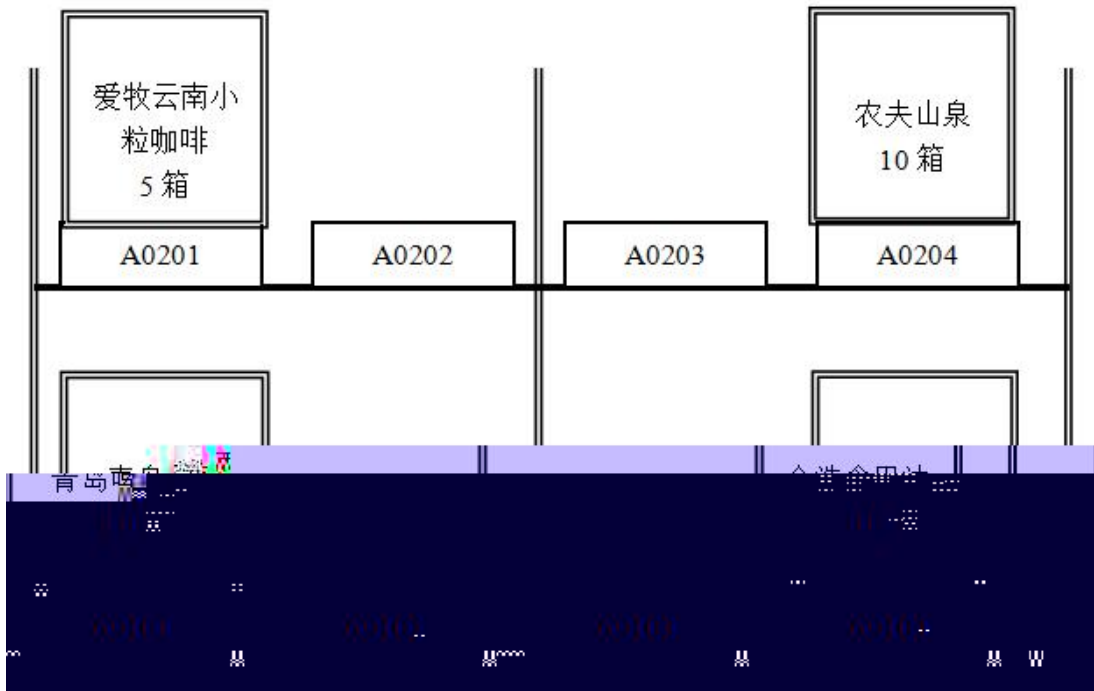

. M

.

.

.

F

•
•
•

①
km

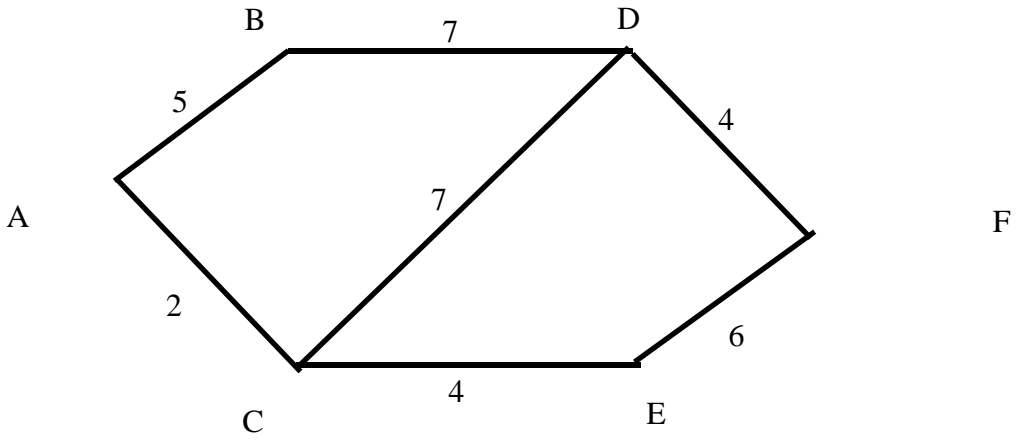

②

5

2

	1	
	2 2 2 2	1 1

		2		1		1		1	
		1		1		F		2	
		2		1		1			
	1200	1000	144			10		10	
				2		1			

3

120

4

	5			1	2 2
	10				1 2 2 1 2
	5			1	2 2 0
50	5				5
	5		M	2	1 2
	5	M	M		4 1
	15		(F)	2	2 2

			(F)	1 3 1 3 F 3
	10			2 2 2 6
	10		M	2 3 3 3 2
30	20			5 10 5
	10			5 5

15. 2-15

1

1

			()		
1			60	3	
2			298	2	
3			3	2	

		---	---		
--	--	-----	-----	--	--

			()		
1			60	2	
2			298	3	
		---	---		

			()		
1			298	4	
2			3	2	
		---	---		

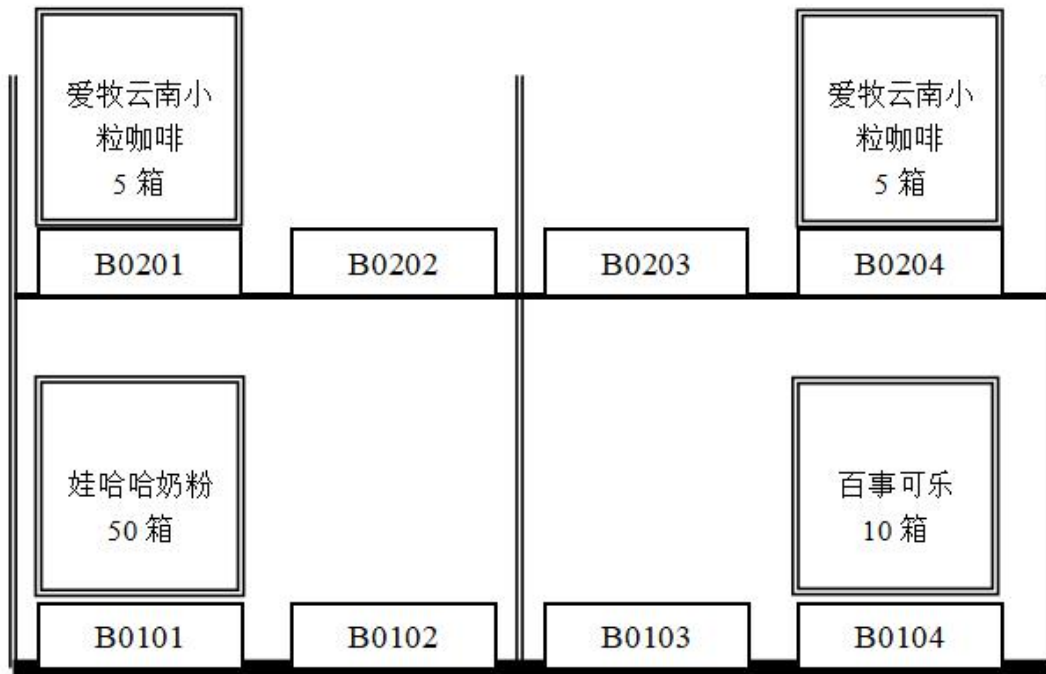
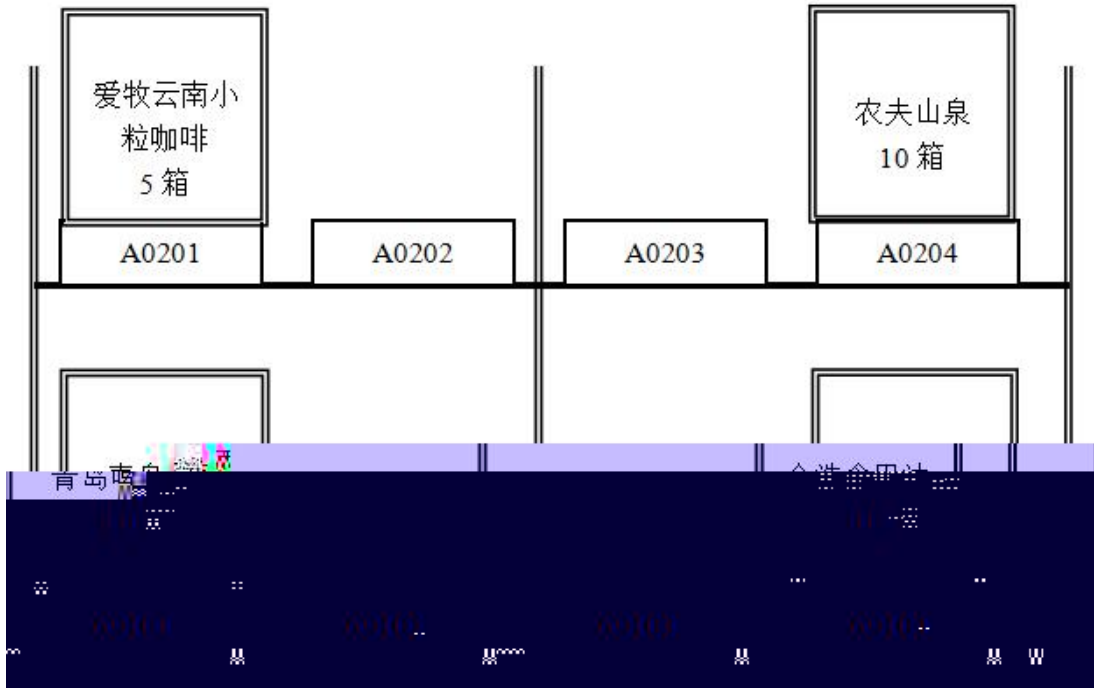

• M

•

•

•

•

•

•

F

①

km

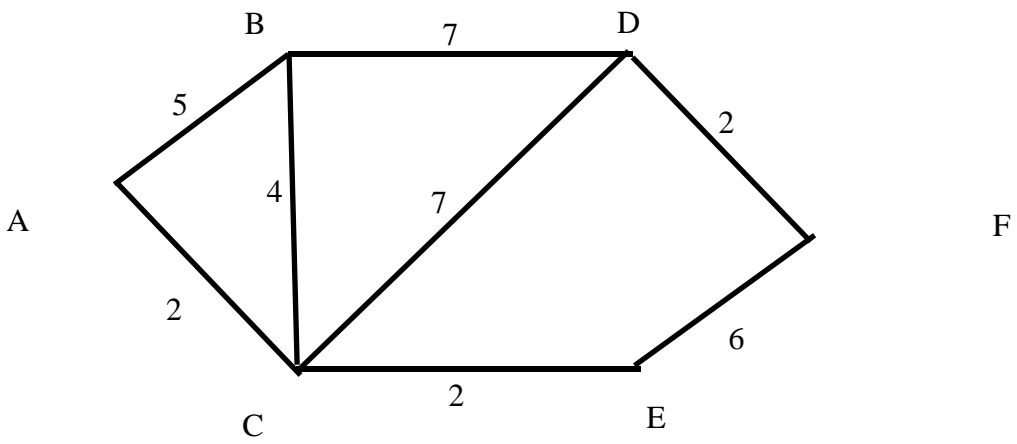

②

2

	1	
	2 2 2 2 1 1	
	2 1 1 F 2 1	
	2 1 1	
	1200 1000 144 10 10	
	2 1	

3

120

4

	5		1 2	0
	10		1 2 2 1 2	
	5		2 2 1	
	5		5	
	5	M	1 2	
			2 1	

50	5	M	M	4 1
	15	(F) (F)		2 2 1 3 1 3 F 3
	10			2 2 6 2
	10	M		2 3 3 2
30	20			5 10 5
	10			5 3 2

16.

2-16

1

	2009081602					
			6-201			0731-63415468
			58966326770051			
	77			230022		
	0731-69912861			0731-63415468		0731-69912880
	@136.			58413516	M N	@ .
				1576784563131450		
				100		
	15					13.75
				B		

	2003020157					
			18			0731-67918998
			1202431325876 76			
	56			23005 1		
	0731-63287689		0731-66858957			0731-63287688
	@ .		698654678	M N		@ .
				87965687975		
				1200		
	200					199.99
				A		

	2008160902					
			3-803			0731-67655865
			120108758377888			
	653			230016		(
	0731-63876590			0731-68657973		0731-63876591
	@ .			2115667907	M N	@ .
				5356899765569		
				3600		
	180					179.8
				A		

			()			
1			4.5	100	450	
2			2	200	400	
3			3	300	900	
4			3	200	600	
			---	---		

			()			
1			4.5	300	1350	
2			2	400	800	
3			3	500	1500	
4			3	200	600	

			()			
1			5	200	1000	
2			2	300	600	
3			4.5	100	450	
4			3	100	300	

①

②

			()		
1			5	2	
2			2	3	
3			4.5	3	
4			3	1	

-
-
-

2

	1	
	2 2 2 2	1 1
	2	1 1 1

	1	1	1	F	2	
	2		1	1		
	1200	1000	144	10	10	
			2	1		

3

120

4

	5			1	2	
	10				1	
					2	2
	5			2	2	
				1	0	
	30			12	0.5	
				8	2	
	15			3	1	
		M			1	10
					2	3
5		M	4	1		
20		(D)	16	2	2	

				2	
				4	
	10		2	4	

17. 2-17

1

	2009081602				
			6-201		0731-63415468
			58966326770051		
	77			230022	
	0731-69912861		0731-63415468		0731-69912880

	@136.		58413516	M N	@ .	
				1576784563131450		
				100		
	15				12.75	
				B		

	2003042301				
					H
			7-301		0731-67535668
			120109278662905		
	888			230061	
	0731-67530866		0731-63520577		0731-67530866
	@162.		663820355	M N	@162.
				62839067352	
				100	
	5				4.9
				B	

	2008160902					
			3-803			0731-67655865
			120108758377888			
	653			230016		(
	0731-63876590			0731-68657973		0731-63876591
	@ .			2115667907	M N	@ .
				5356899765569		
				3600		
	180					178
				A		

			()		()	
1			2	200	400	
2			2	400	800	
3			4.5	200	900	

			()			
1			4.5	100	450	
2			2	400	800	
3			3	500	1500	
4			3	200	600	

			()			
1			4.5	200	1000	
2			2	300	600	
3			3	100	450	
4			3	100	300	

①

②

			()			
1			4.5	2	9	
2			2	2	4	
3			3	3	9	
4			3	1	3	
		---	---			

·
·
·

2

	1	
	2 2 2 2	1 1
	2	1 1 1

	1	1	1	F	2	
	2		1	1		
	1200	1000	144	10	10	
			2	1		

3

120

4

	5			1	2	
	10				1	
					2	2
	5			2	2	
				1	0	
	30			12	0.5	
				8	2	
	15			3	1	10
			M			3
						2
5		M	4	1		
20		(D)	16	2	2	

				2	
				4	
	10		2	4	

18. 2-18

1

	2003042301				
					H
			7-301		0731-67535668
			120109278662905		
	888			230061	
	0731-67530866		0731-63520577		0731-67530866
	@162.		663820355	M N	@162.

					62839067352		
					100		
	6						4.9
					B		

2003020157

1202 18 0731-67918998

	2008160902					
			3-803			0731-67655865
			120108758377888			
	653			230016		(
	0731-63876590			0731-68657973		0731-63876591
	@ .			2115667907	M N	@ .
				5356899765569		
				3600		
	10					9.8
				A		

			()			
1			4.5	200	900	
2			2	100	200	
3			3	200	600	

			()			
1			4.5	300	1350	
2			2	300	600	
3			3	300	900	
4			3	500	1500	

			()			
1			5	100	1000	
2			2	200	600	
3			4.5	100	450	
4			3	500	300	

①

②

			()		
1			4.5	4	1
2			2	3	2
3			3	1	3
4			3	2	4

-
-
-

2

	1	
	2 2 2 2	1 1
	2	1 1 1
	1 1	1 F 2

	2	1	1	
	1200	1000	144	10 10
		2	1	

3

120

4

	5		1	2 2	
	10		2	1 2 1 2	
	5		1	2 2	
				0	
	30		12	0.5	
			8	2	
	15	M	3	1	10 3
					2
	5	M	4	1	
20	(D)	16	2	2	
			2		

		10		4	
				4	
			2		

19.

2-19

100

10

	2003042301				
					H
			7-301		0731-67535668
			120109278662905		
	888			230061	
	0731-67530866		0731-63520577		0731-67530866
	@162.		663820355	M N	@162.
				62839067352	
				100	
	5				4
				B	

			()			
1			4.5	100	450	

2			2	100	200	
3			3	100	300	
4			3	100	300	

			()			
1			4.5	300	1350	
2			2	300	600	
3			3	600	1800	

			()			
1			5	300	1500	
2			2	300	600	
3			3	100	300	

①

②

--	--

			()		
1			4.5	2	
2			2	1	
3			3	3	
4			3	1	
		---	---		

-
-
-
-

2

	1	

	2	2	2	2		1		1	
			2		1		1	1	
		1		1	1	F		2	
	2			1		1			
	1200	1000	144		10			10	
			2		1				

3

120

4

	5			2	0	
				1		2
	10			1		2
				2		
				1		
	5			2		
				2		
				1		
	30			12	0.5	
				8	2	
	15			3	1	
		M			1	10
					2	3
5				4	1	
	20		(D)		2	
				16	2	

				2	
				4	
	10		2	4	

20.

2-20

1

	2009081602				
			6-201		0731-63415468
			58966326770051		
	77			230022	
	0731-69912861		0731-63415468		0731-69912880
	@136.		58413516	M N	@ .

				1576784563131450		
				100		
	15					14.75
				B		

	2003020157					
			18		0731-67918998	
			1202431325876 76			
	56		23005 1			
	0731-63287689		0731-66858957		0731-63287688	
	@ .		698654678	M N	@ .	
				87965687975		
				1200		
	100					99.99
				A		

2008160902

3-803

0731-67655865

			()			
1			4.5	100	450	
2			2	400	800	
3			3	200	600	
4			3	100	300	

			()			
1			5	100	500	
2			2	700	1400	
3			4.5	100	450	
4			3	100	300	

①

②

			()		
1			2	3	
2			3	8	
3			3	3	

-
-
-
-

2

	1	
	2 2 2 2 1 1	
	2 1 1 1 F 2 1	
	2 1 1	

	1200 1000 144	10	10	
		2	1	

3

120

4

5

		10		4	
				4	
			2		

三、

示物

1.

1

1



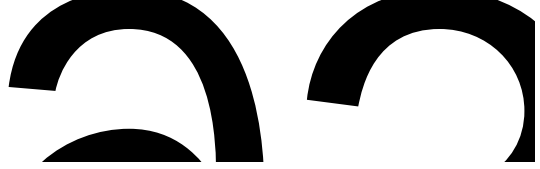

	2	30
		1 30 40
	0	5
		30
	30	2

3

90

4

5

3
2

(20)

$\frac{10}{2}$

0

	10		5	
			10	
	20		10	20
			10	
	25		10	
			10	
			5	
			25	

2. 3-2

1

1

,

①

,

:

:

:

:CIF

:

:35

:40

:40

1 - 8

1		
2	4	5

		6
		/
3		

7	8
---	---

			1	1	1
40 3	35		I 0	1AA	1CC
	D1 000/ E	D1 800/FE			

F
 2002/C NO. 245789
 NE 0 K
 NO. 1 40

5

 35 40 40
 300 / /M

2

2

	2	30
		1 30 40
	0	5
		30
	30	2

3

90

4

			2 10	2
	20			20
	25		10 10 5 25	

3. 3-3

1

1

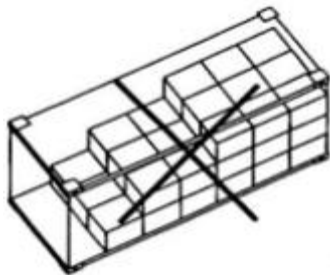

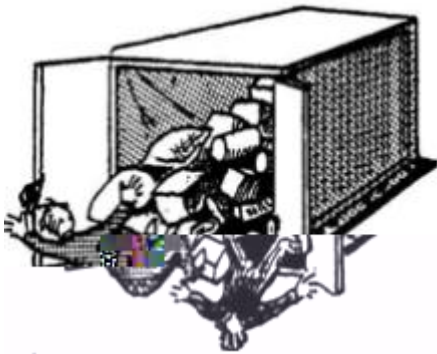
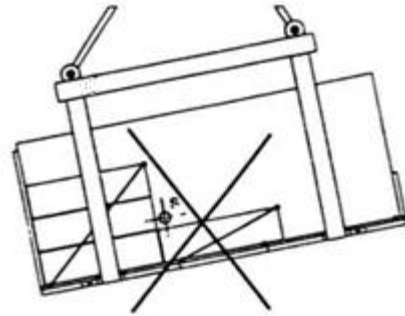
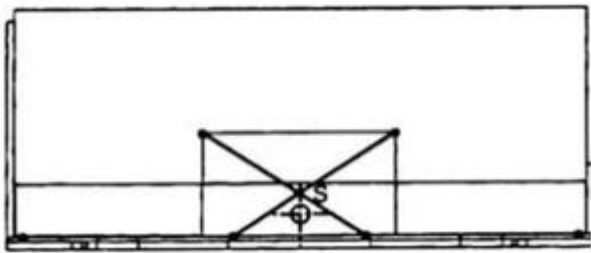

MCO

2020/C NO. 245789

NE 0 K

NO. 1 20

5 20

19.5 3

15

D18.5M

21.5

2

2

	2	30
	1	30 40
	0	5
		30
	30	2

3

90

4

(20)	5		3 2	0
	10		4 4 2	
	5		2 3	
(80)	15		3 15	
	10		5 10	

			I 0	
	10			2 2 10
	20			20
	25			10 10 5 25

4.

3-4

1

1

A

B

CON AC N .123456

20

①

船公司 Carrier	船名/航次	服务代码	航线	装船港/卸船港	启-达日期	天	挂港
MSC 地中海航运	MASTER HQ409E		中国-香港	HONG KONG 香港 KAOHSIUNG 高雄	02/25(二) 03/15(六)		18
NYK 日本邮船	ITALIAN EXPRES S/024		中国-东南亚	HONG KONG 香港 BANGKOK 曼谷	02/25(二) 03/02(日)		5
CMA-CGM 达飞轮船	CMA CGM GEMINI TXA49E		中国-非洲	XIAMEN 厦门 DURBAN 德班	02/25(二) 03/27(四)		30
KLINE 川崎汽船	HYUNDAI PLATINUM M/004W		中国-中南美	SHANGHAI 上海 PARANAGUA 巴拉那瓜	02/25(二) 04/09(三)		43
DMS 达茂轮船	COSCO KAOHSIUNG G/GFS46E		中国-澳新	HONG KONG 香港 NOUMEA 努美阿	02/25(二) 04/02(三)		36
RCL 招商局	KOTA PERMASAN VPM114		中国-中东/ 波斯湾/印巴	QINGDAO 青岛 MADRAS 马德拉斯	02/28(五) 03/18(二)		18
ZIM 以星轮船	KUO HUNG 311	CHINA_VIETNAM AM(CVX)	中国-香港	NINGBO 宁波 HONG KONG 香港	02/25(二) 03/15(六)		18
SAPMARINE 比利时商船	HEIKE P 1404		中国-非洲	KAOHSIUNG 高雄 MINDELO	02/25(二) 04/05(六)		39
CSAV 南美船	CAP SAN NICOLA S/01409		中国-中南美	SHANGHAI 上海 RIO GRANDE 里奥格兰德	02/25(二) 04/07(一)		41
OOCL 东方海外	DRESDEN EXPRES S/16E08	Pacific Atlantic (PAX)	中国-美东	SHANGHAI 上海 HALIFAX 哈利法克斯	02/25(二) 04/14(一)		48

. E D E A

.

.

3

5

A B

20 17.8 A

D BAN CA E O N

D80.0/F D3.0

/M

.

B A ?

D1100.0/ E

10 10 (

)?

.

?

2

2

	2	30
	1	30 40
	0	5
		30
	30	2

3

90

4

(20)	5		3 2	0
	10		4 4 2	
	5		2 3	
(80)	15		5	
	10		5 10	

	10		I 0	10
	20			20
	25			10 10 5 25

5. 3-5

1

1

②

③

.

.

4

.

.

.

5

N

G

,

BEIJING CHINA BJ

BO ON . .A BO

(20)		5			3 2
		10			4 4 2
		5			2 3
(80)		15			5 10 15
		10			10
		10		I 0	5 10
		20			6 7 20
		25			10 10 5 25

6.

3-6

1

1

KI

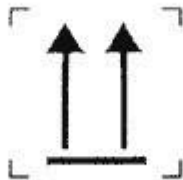

④

5

23

1200

20

20 20 25

100 /

/M

10%

10%

2

2

	2	30
	1	30 40
	0	5
		30
	30	2

3

90

4

(20)	5		3 2	0
	10		4 4 2	
	5		2 3	
(80)	15		15	
	10		4 10	
	10		I 0	

				10	3 2
		20			20
		25		25	10 10 5

7. 3-7

1

1

②

③

4

5

36.4

82 48

32

6000

1

BEIJING . ENMINGBI	CN CN		BJ KG
NE O K N C	. . A	M N 45 100 300	630.00 64.46 48.34 45.19 41.80

2

2

	2	30
	1	30 40
0	5	
	30	
30	2	

3

90

4

(20)	5		3 2	0
	10		4 2	
	5			

				2 3	
(80)		15		5 10	
		10			10
		10		I 0	10
		20			20
		25		10 10 5	25

8.

3-8

1

1

5

. M.

C20130201

OK 0

N .:1 100

2020 2 15

1 5

1		
	4	5
2		
		/
3		

集装箱设备交接单
EQUIPMENT INTERCHANGE RECEIPT

OUT 出场

用箱人/运箱人(CNTR. USER/HAULIER)		提箱地点(PLACE OF DELIVERY)	
发往地点(DELIVERED TO)		返回地点(PLACE OF RETURN)	
船名/航次(VESSEL/VOYAGE)	集装箱号(CNTR. No.)	尺寸(SIZE/TYPE)	营运人(CNTR. OPTR)
箱号(Seal No.)	箱封号(SEAL No.)	免费期限(FREE TIME PERIOD)	运载工具牌号(TRUCK WAGON BARGE No.)
货重(CARGO W.)	出场目的/状态(PPS OF GATE-OUT/STATUS)	进场目的/状态(PPS OF GATE-IN/STATUS)	出场日期(TIME-OUT) 月 日 时
出场检查记录(INSPECTION AT THE TIME OF INTERCHANGE)			
普通集装箱(GP. CNTR.)	冷藏集装箱(RC. CNTR.)	特种集装箱(SPL. CNTR.)	发电机(GEN. SET)
<input type="checkbox"/> 正常(SOUND) <input type="checkbox"/> 异常(DEFFECTIVE)	<input type="checkbox"/> 正常(SOUND) 设定温度(SET) <input type="checkbox"/> 异常(DEFFECTIVE) 记录温度(RECORDED)	<input type="checkbox"/> 正常(SOUND) <input type="checkbox"/> 异常(DEFFECTIVE)	<input type="checkbox"/> 正常(SOUND) <input type="checkbox"/> 异常(DEFFECTIVE)
损坏记录及代号(DAMAGE CODE)			
如有异常, 请注明程度及尺寸(REMARK)			
除列明者外, 集装箱设备交接时完好无损, 箱体完整无漏。 * CONTAINER EQUIPMENT INTERCHANGED IN SOUND CONDITION AND SEAL INTACT UNLESS OTHERWISE STATED			
用箱人/运箱人签署 (CONTAINER USER/HAULIER'S SIGNATURE)		码头/堆场值班员签署 (TERMINAL/DEPOT CLERK'S SIGNATURE)	
年 月 日		年 月 日	

M.
C20130201
OK 0
N .:1 400
4
⑤

1/:/

2

2

	2	30	
		1	30 40
	0	5	
		30	
	30	2	

3

90

4

(20)	5		3 2	0
	10		4 4 2	
	5		2 3	
(80)	15		3 15	
	10			

5
10
10
10
2 2
10
10
20

L (5)

D (6)

(7)

M N	N .	D	G	M
	(8)	(9)	(10)	

(I)

F

C

D

.
. .

:

B I . A E . C , M C . , 126
 , B B , 3600 , 20
 CF , 10 , 50 *20 *30 , 10
 / , () :ML /AN E EI /NO :1-30 2020 5 18
 E0002 MA B123456

2

2

	2	30
	1	30 40

	0	5	
		30	
	30	2	

3

90

4

(20)	5		3 2	0
	10		4 4 2	
	5		2 3	
(80)	20		2 20	
	20		20	
	20		5 5 20	
	20		20	

				20	
--	--	--	--	----	--

10.

3-10

1

1)

B C

F



CIF

CIF

5

2

2

	2	30	
		1 30 40	
0	5		

	30	
30	2	

3

90

4

(20)	5		3 2	0
	10		4 4 2	
	5		2 3	
(80)	20		8 6 20	
	20		20	
	20		20 10	
	20		20 10	

11.

3-11

1

1)

ABC C L
0

N

C L



.
. .
. .

C L

CIF

.
. .
. .

ABC

100

30

5 :

2019 ABC

5 6

10

6

26

D/



2020 3

4

.
.
2

2

	2	30
	0	1 30 40
		5
		30
	30	2

3

90

4

(20)	5		3 2	0
	10		4 4 2	
	5		2 3	
	20			

(80)				20
		20		20
		20		20 10
		20		10 20

12. 3-12

1

1)

1

A N 1 C N 4 5 A 2-C M
 N J
 B C N M I E C B
 C



B C B B F

. ?
 . ?
 . ?
 2

3

CIF

.
.
.
4

5

2

2

	2	30
		1 30 40
	0	5
		30
	30	2

3

90

4

	5		3	
(20)			2	
	10		4	0
			4	

2

5

2

3

20

(80)

HANGHAI . ENMINBI	CN CN		HA K
A I	F	M	320.00
		N	50.22
		45	41.43
		300	37.90
		500	33.42
		1000	30.71

N	G	K L	C	C	/		N G (I .D)
			C I N .				

2

3

4

2

2

--	--	--

	2	30	
	0	5	1 30 40
		30	
	30	2	

3

90

4

(20)	5		3 2	0
	10		4 4 2	
	5		2 3	
(80)	20		20	
	20		20	
	20		20 10	
	20		20	

				10	20	
--	--	--	--	----	----	--

14. 3-14

1

1

:

.

.

.

.

.

.

.

.

CO. L D.

.

CO. L D. ?

.

B/L N .

HANGHAI KNI EA

IM O & E O

CO O A ION

C

O O DE

N

CO. L D. ,

EL NO 81-525-73256

FA : 81-525-73286

HANGHAI

COMBINED AN O

BILL OF LADING

ECEI E

. HE

C ,

0

L

1)

M. .G

HANGHAI

, 2)

0

L

D D F N
 OKOHAMA HANGHAI B /L
 M N .N D H EE(3)
 (.) M (3)
 CO. L D., ALL CO ON C HION

OKOHAMA IN CA ON 1200 58KG 898M3

CA ON/NO. 1-80 2 20 C C

CON AINE N M EA 2336683

EAL N M 001294

MADE IN CHINA HI E LOAD CO N AND EAL

A O CON AIN

F EIGH E AID

ABO E A I LA F NI HED B HI E

F IN I NE

L

()

HANGHAI

N .20 , 2003

FAN CHENG IN E NA IONAL

AN - O AION EA ICE A AGEN FO

HE CA IE NAMED ABO E

BJEC O HE E M AND CONDI ION ON BACK

CF

•
•

•
•
•

CIF 12000

0.6% 0.4%

5
2019 9 8

12000 /
10 16

3 11 5 12 14

12000

2

2

	2	30

	1	30 40
	0	5
		30
	30	2

3

90

4

5

(20)

				20	
--	--	--	--	----	--

15. 3-15

1

1

B CHINA BJ AM E DAM HOLLAND AM

C

A

G



D

101 58 32

BEIJING	CN	BJ
. ENMINBI	CN	K
AM E DAM	NL	M 320.00
		N 50.22
		45 41.53
		300 37.52

N .	G	K L	C	C	/		N G (I .D)
-----	---	--------	---	---	---	--	-------------------

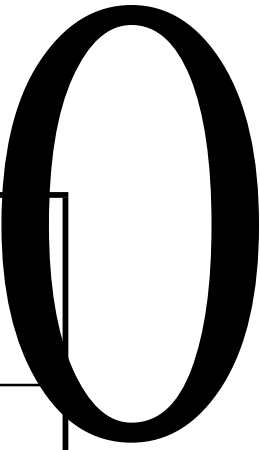

				C				
				I				
				N .				

④

:

2

38.6

D320000

999-8334-

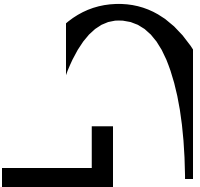

4

(20)	5		3 2	0
	10		4 4 2	
	5		2 3	
(80)	20		20	
	20		20	
	20		20 10	
	20		20	

16.

3-16

1

1)

2019

8

ABC

:

ABC C . L .

C O O DE

N C . L .

O M

L :

D :

:1234CN/5678J

D G : EHICLE 2*20 C 4 NI

CO 8001215 OC 802376

F

N . O B/L:

:DEF C .,L .A ACEN FO CHI C .,L .A

CA IE

CO

OC

.

.

.

.

.

.

.

.

C .,L .

.

C .,L .

.

.

.

·
·

2019 8 ABC FOB

2

2

	2	30	
		1 30 40	
	0	5	
		30	
	30	2	

3

90

4

(20)	5		3 2	0
	10		4	

				4	2
		5		2	3
(80)		20			20
		20		20	
		20		20	10
		20		10	20

17. 3-17

- 1
- 2 20 J
- MM A
- 2 21 18:00 100
- 2 21 18:30 A
- 10
- 1)
- ②

③

?

*

*			
*			001
*			
*			
*			
*			

:

:

18: 00

2020. 02. 21 02: 00

2 20

4

(20)	5		3 2	0
	10		4 4 2	
	5		2 3	
(80)	15		5 15	
	15		15	
	30		30 15	
	20		20 10	

18.

3-18

1

A B

FOB

D

D

A

B

A

A

B

1

B

@126.

2

2

	2	30
	1	30 40
0	4	
	30	
30	2	

				4	2
		5		2	3
(80)		15		5	15
		15		15	5
		30		30	15
		20		20	10

19.

3-19

1

20 80

140

2

2

	2	30
		1 30 40
	0	4
		30
	30	2

3

90

4

(20)	5		3	

				2	
				4	0
	10			4	2
	5			2	3
(80)	15			7 15	8
	15			8	7 15
	30			30	15
	20			20	10

20.

3-20

1

1907

2400

16

610

34

1.

:

3

;

8

1

20

90

180

24

2.



3.



4.



5.



①

3



2

2

	2	30
		1 30 40
	0	4
		30
	30	2

--	--	--

3

90

4

(20)	5		3 2	0
	10		4 4 2	
	5		2 3	
(80)	15		5 15	
	15		15 5	
	30		30 15	
	20		20 10	

21.

3-21

1

1990

2004

4000204446

.

2004

200

2007

6000

1990

3

200

300

4000204446

.

24

1)

18

2

3

2

2

	2	30	
		1	30 40
	0	4	
		30	
	30	2	

3

90

4

(20)	5		3 2	0
	10		4 4 2	
	5		2 3	
(80)	15		5 15	
	15			

			8	7 15
	30		30	15
	20		20	10

22.

3-22

1

() () 1961 4

27 700 4100

4 160 1400

32 147

4000 77 104

29 400

C

2002

C

1)

18

2

3

2

2

	2	30

	1	30	40
0	4		
	30		
30	2		

3

90

4

(20)	5		3 2	0
	10		4 4 2	
	5		2 3	
(80)	15		15	
	15		8 7 15	
	30		30 15	
	20		10	

				20	
--	--	--	--	----	--

23. 3-23

1

2020 4 20

A B

A B 2020 6 9

B

C

1)

①

②

③

2

2

	2	30	
		1	30 40
0	4		
	30		
30	2		

3

90

4

5

3

2

4

4

2

0

(20)

10

5

2

3

15

7

8

15

15

(80)

30

10

30

20

Gy

140

(ô)

7

				4	2
		5		2	3
(80)		15		5	15
		15			15
		30		30	15
		20		20	10

25.

3-25

1

3

FOB

3

2

2

1)

2

?

2

2

	2	30
		1 30 40
	0	4
		30
	30	2

3

90

4

(20)	5		3 2	0
	10		4 4 2	
	5		2 3	

(80)	15		7 15	8
	15			15
	30		30	10
	20		20	10

四、 快递物流作业组织与管理模块

1. 4-1

1

1

:

20100289B

3

2013 11 29

2013 12 20

2 11 29

3

2013 11 30

1

2

3

M 4



4

4

?

4

5

60

40

30

5

6

12

	1	
	10	8

7

8

,

?

2

2

	1	30	
		1	30 40
0	5		

	30	
30	2	

3

90

4

	10			5 5
	10			0
	10			2 8
	10			1 6
	10			8 2
	10			8 2
	10			5 10 2
	20			10 2
	10			5 1

2.

4-2

1

1

6000

51

9 18

13

117

10

3

3

3

3

12 24

6000

:// . . /

3

2

8860

43300

A2141552

4

1

2

3

M 4



4

4

?

4

5

60

40

30

5

6

12

	1	
	10	8

7

8

,

?

2

2

	1	30	
		1	30 40
0	5		

	30	
30	2	

3

90

4

	10			5 5
	10		5 5	0
	10		2 8 1	
	10		6 1	
	10		8 2	
	10		8 2	
	10		5 10 2	
	20		10 2	
	10		5 1	

3.

4-3

1

1

50

50

3

5000

2

2

8

4

:// . . / / / /321751.

1

2

M 4

3



4

4

?

4

5

60

40

30

5

6

12

	1	
	10	8

7

8

,

?

2

2

	1	30

	1	30 40
	0	5
		30
	30	2

3

90

4

	10			5 5
	10			5 5 0
	10			2 8
	10			1 6
	10			1 8 2
	10			8 2
	10			5 10 2
	20			10 2

		10		1 ⁵	
--	--	----	--	----------------	--

4.

4-4

1

1

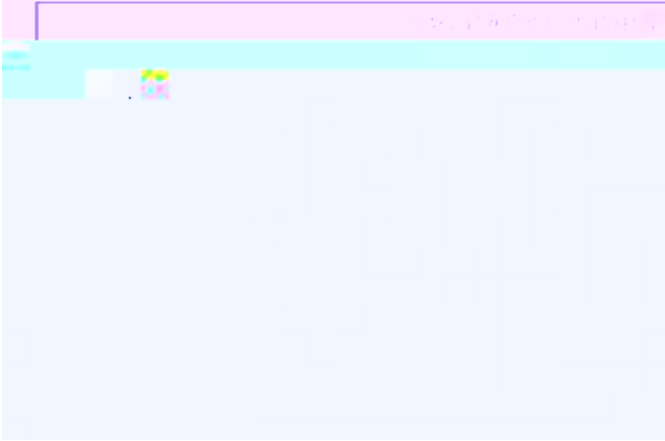
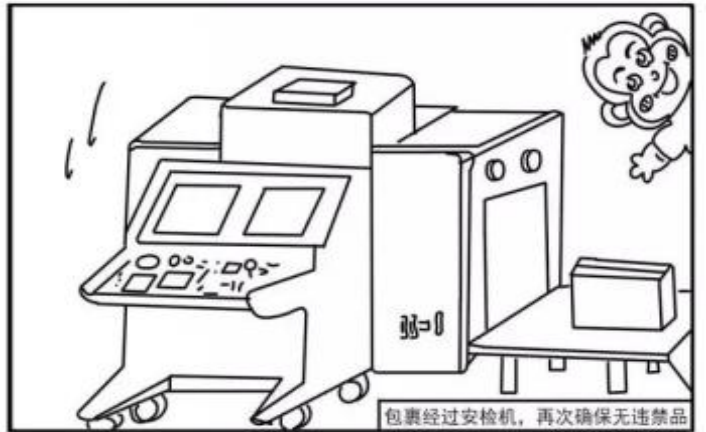
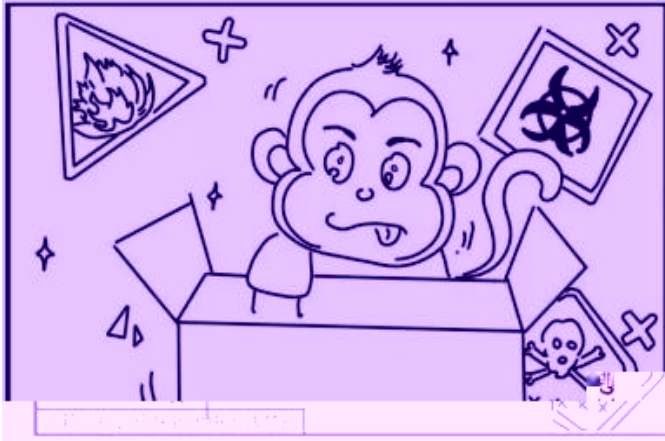

:// . . //210815637 660512

1

2

M 4

3



4

4

?

4

5

60

40

30

5

6

12

	1	
	10	8

7

8

,

?

2

2

1

-

2

	1	30 40
	0	5
		30
	30	2

3

90

4

	10			5 5
	10			5 5 0
	10			2 8
	10			1 6
	10			1 8 2
	10			8 2
	10			5 10 2
	20			10 2

		10		1 ⁵	
--	--	----	--	----------------	--

5. 4-5

1

1

1

2018 4

4

(

2

2

M 4

3



4

4

?

4

5

60

40

30

5

6

12

	1	
	10	8

7

8

,

?

2

2

	1	30
		1 30 40
0	5	
	30	
30	2	

--	--	--

3

90

4

	10			5 5
	10			5 5 0
	10			2 8 1
	10			6 1
	10			8 2
	10			8 2
	10		10	5 2
	20		10	2
	10		1	5

6.

4-6

1

1

, , () ,

90

, ,

, ,

,

,

,

10

,

1

,

4000

()

,

,

,

,

10

,

5000

1

2

M 4



3

4

4

?

4

5

60

40

30

5

6

12

	1	
	10	8

7

8

,

?

2

2

	1	30
		1 30 40
0	5	
	30	
30	2	

3

90

4

		10		5	
				5	
		10		5	0
				5	
		10		2	
				8	
				1	
		10		6	
				1	
		10		8	2
				8	2
	10		5		
			10	2	
	20		10		
				2	
	10		5		
			1		

7. 4-7

1

1

7

5000

2000

50 250

250

9

14

7000

18K

1

5 8

5

10

()

10

30

<://.360./ /998684 3 4 3 ? =4>

& = & =360 57 3 1& = 1

1

2

M 4

3



4

4

?

4

5

60

40

30

5

6

12

	1	
	10	8

7

8

,

?

2

2

	1	30

	1	30	40
	0	5	
		30	
	30	2	

3

90

4

	10		5	
			5	
	10		5	0
			5	
	10		2	
			8	
			1	
	10		6	
			1	
	10		8	2
			8	2
	10		5	
			10	2
	20		10	2
			5	
	10		1	

--	--	--	--	--	--

8. 4-8

1

1

[想知道: 中国成都理工大学校园快递具体在哪? 百度知道](#)

3个回答 - 提问时间: 2014年02月10日

最佳答案  均在银杏后面。宝盒、圆通、顺丰在电影院后面。中通、申通在图书馆下面。常用的是这几个。

[zhidao.baidu.com/link?... 2014-02-15](#) - 百度快照 - 80%好评

10

60

300

0.5

150

4500

2

60

120

3600

8100

8100

8100

2

250

24

A M

0.2

0.1

0.1

20%

70%

1

2

4

	10			5 5
	10			5 5 0
	10			2 8 1
	10			6 1
	10			8 2
	10			8 2
	10			5 10 2
	20			10 2
	10			5 1

S

200

*

200

*

1

2

3

4

M 4



4

?

4

5

60

40

30

5

6

12

	1	
	10	8

7

8

,

?

2

2

	1	30
	1	30 40
0	5	
	30	
30	2	

3

90

4

	10		5
			5
	10		5
			0
	10		2
			8
			1
	10		6
			1
	10		8
			2
	10		8
			2

		10		10 ⁵ 2	
		20		10 ²	
		10		1 ⁵	

10.

4-10

1

1

65 (

)

20100289B

3

1

2

3

M 4



4

4

?

4

5

60

40

30

5

6

12

	1	
	10	8

7

8

,

?

2

2

	1	30	
		1 30 40	
	0	5	
	30		
	30	2	

3

90

4

--	--	--	--

	10		5	0
			5	
	10		5	
			2	
	10		8	
			1	
	10		6	
			1	
	10		8	2
			8	2
10		5	2	
		10	2	
20		10	2	
		5		
10		1		

11.

4-11

1

1

9

1

2

3

4

5

6

7

8

2

2

	1	30	
		1	30 40
	0	5	
		30	
	30	2	

3

90

4

	10		5	
			5	
	10		5	0
			5	
	15		5	
			1	

		10		5 5 1	
		10		5 1	
		15		5 1	
		10		5 2	
		10		5 5	
		10		5	

12. 4-12

1

1

8 4 17

11 8 5 17

8 6

8 6 16

16

4008111111

1

2

3

4

5

6

7

8

2

2

	1 30	
	1 30 40	
0	5	
	30	
30	2	

3

90

4

10

			5	
		15	5 1	
		10	5 5 1	
		10	5 1	
		15	5 1	
		10	5 2	
		10	5 5	
		10	5	

13.

4-13

1

1

(

12

298

12 19

298

10

1880

220

10

220

1

2

3

4

5

6

7

8

2

2

	1 30	
	1 30 40	
0	5	
	30	
30	2	

3

90

4

--	--	--	--

	10			5 5
	10			5 5 0
	15			5 1
	10			5 5 1
	10			5 1
	15			5 1
	10			5 2
	10			5 5
	10			5
	10			5

14.

4-14

1

1

5 1

470

8000

10

6200

10 23

12 1

1

3

1

2

3

4

5

6

7

8

		10		5	0
		15		5	
		10		5 5	
		10		1	
		10		5	1
		15		5	1
		10		5	
		10		2	
		10		5	
		10		5	
		10		5	

15. 4-15

1

1

1

8 4 17

11 8 5 17

8 6

8 6 16

16

4008111111

()

1

2

3

4
5
6
7
8

2

2

	1 30	
	1 30 40	
0	5	
	30	
30	2	

3

90

4

		15		5 1
		10		5 5 1
		10		5 1
		15		5 1
		10		5 2
		10		5 5
		10		5

16.

4-16

1

1

11 23

11 24

45KG

0.3

11 25

11 26

12 3

12 6

1

2 11 26

3

4

?

5

6

7

?

8

2

2

	1 30	
	1 30 40 0	
	5	
	30	
	30 2	

3

90

4

	10		5
			5

		10		5	5	0
		15		1		
		15		5	10	
		10		5	5	
		10		5	1	
		15		5	5	1
		15		5	2	10
		15		5	1	
		15		10		
				1		

17. 4-17

1

1

A

11 19

A

11 20

11 20

A

11 27

11 27

A

A11

28

11 28

A

17 30

A A

11

29

A

9 15

A

A

11 29

9 30 A

28

11 29

10

15

3

4

A

11 29

14 00 A

A

11 29 14 15 A

A

A

A

A

1

2

A

3

A

4

4

?

5

6

7

?

8

2

2

	1	30
	1	30 40 0
	5	
	30	
	30	2

3

90

4

	10		5	
			5	
	10		5	0
			5	
	15		1	
			5	
	15		10	
			5	

10 5 5 5
10 1 5 5 5
15 5 1 10
15 5 2 10
15

18. 4-18

1
1
8 800
10
8 2 10 /
10 9 /
8 12 7 2080

1

2

3

4

5

6

7

?

8

2

2

1

30

1

30 40

		10		5	
				5	
				5	
		10		1	5
				5	1
		15			10
				2	
				5	
		15			5
				1	10
				1	

19.

4-19

1

1

8 20

10

123

12

0291234567

11

0281234567

234

10

10

1

2

3

4

?

5

6

7

?

8

2

2

	1	30
	1	30 40 0
	5	
	30	
	30	2

3

90

4

	10		5	
			5	
	10		5	5
			5	0
	15			1

		15		5 10 5	
		10		5 5 1	5
		10		5	
		15		5 1	10
		15		2 5 1 1	5 10

20.

4-20

1

1

5 23

5 24

3876

45KG

0.3

5 25

5 26

6 3

6 6

**

1

2 11 26

3

4

?

5

6

7

?

8

2

2

	1	30
	1	30 40 0
	5	
	30	
	30	2

3

90

4

	10		5
	10		5
		5	0

				5	
		15			1
		15			5 10 5
		10			5 5 5
		10		1	5
		15			10
		15			5 1 10
		15			1 1

21. 4-21

1

1

11 23

11 24

45KG

0.3

11 25

11 26

12 3

12 6

1

2 11 26

3

		10		5 5	0
		15		1	
		15		5 10 5	
		10		5 5 1	
		10		5	
		15		1 10	
		15		2 5	
		15		1 10 1	

22.

4-22

1

1

C

B

A

3

11 19

A

11 20

11 20

A

C

11 27

C 11 27

A

A11 28

11 28

B

A

17 30

A A

11

29

A

B9 15

A

A

11 29

9 30 A

28

11 29

10 15

3

4

B

A

11 29

14 00 A

C

C

A

11 29 14 15 A

B

A

A

A

A

1

A

2

A

3

4

5

6

7

?

8

2

2

	1	30
	1	30 40 0
	5	
	30	
	30	2

3

90

4

	10		5	
	10		5	0
	15		1	
	15		5 10 5	
	10		5	5

				1	5	
		10				5
		15		5	1	10
		15			2	5
				5		10
					1	5
						10
					1	

23.

4-23

1

1

7 23

3

705

7

02231234567

4

02411234567

234

3 20

10

1

2

3

4

5

6

7

?

8

2

2

	1	30
	1	30 40 0
	5	
	30	
	30	2

3

90

4

	10		5	
	10		5	0
	15		1	

	15			5 10 5	
	10			5 5 1	5
	10			5 1	5
	15			2 5	10
	15			1 1	5 10

24.

4-24

1

1

9

500

10

8

2

15 /

10

14 /

2014

9

12

**

3

1

2

3

4

?

5

6

7

?

8

2

2

	1	30
	1	30 40 0
	5	
	30	
	30	2

3

90

4

	10		5	
	10		5	0
	15		1	

		15		5 10 5	
		10		5 5 1	5
		10		5	
		15		5 1	10
		15		2 5 1 1	5 10

25.

4-25

1

1

9

6 300

5 250

5

500

500

15000

6

300

4700

2

600



1

2

3

4

5

6

7

8

2

2

?

?

		1	30
		1	30 40
		5	0
		30	
	30	2	

3

90

4

-------	--

		10		5	
		10		5	0
		15		1	
		15		5 10 5	
		10		5 5	
		10		1	5
		15		5	10
		15		2	5
		15		1	10
		15		1	